



INDICATOR-TOTALIZER RECORDER

MODEL IN48-2

12" Circular Chart

Two 4-20 mA Inputs

QUICK REFERENCE MANUAL



3255 WEST STETSON AVENUE
HEMET, CALIFORNIA 92545 U.S.A.

PHONE: 951-652-6811
FAX: 951-652-3078
VISIT OUR WEBSITE: www.mccrometer.com
E-MAIL: info@mccrometer.com

CONTENTS

WIRING 3

WIRING CONTINUED..... 4 - 7

WIRING DIAGRAM 5

STEPS FOR MAXIMIZING PEN LIFE 8

OPERATING THE RECORDER 8

DISPLAY AND KEY PAD DESCRIPTIONS 9

KEY PAD DESCRIPTIONS CONTINUED 10

ERROR MESSAGES 11 - 14

SETTING START UP TIME 15

CHANGING CHART RANGE..... 16

CHANGING CHART SPEED 17

CHANGING TIME 18

RESETTING TOTALIZER 18

CONFIGURATION RECORD SHEET 19 - 21

ENABLING AND DISABLING LOCKOUT 22

INDEX 23

* ALL FIGURES AND TABLES REFER TO THE PRODUCT MANUAL.

WIRING

INPUT WIRING PROCEDURES

Refer to Figure 2-9* and follow the procedure in Table 2-10 to connect the AC line power.

WARNING Be sure that the line voltage is OFF before connecting the power wires to the recorder or personal injury could result.

Table 2-10 AC Line Power Wiring

Step	Action
1	Open the recorder door. Loosen the captive screw in the chart plate and swing the plate out.
2	Locate connector J10 on the bottom edge of the main printed circuit board. (Refer to Figure 2-9.)
3	Remove the unwired plug from J10.
4	Run the power wires separately through second conduit from the right.
5	Strip 1/4-inch maximum of insulation from the end of each wire.
6	Loosen the screws in plug J10 terminals and position the plug as you would to plug it into J10.
7	<p>Insert the <i>green</i> wire (G) into the first screw clamp from the right, the <i>white</i> wire (L2) into the second screw clamp from the right, and the <i>black</i> wire (L1) into the third screw clamp from the right. Tighten the screws to secure the wires.</p> <p>CAUTION To avoid damaging the recorder, be sure that you install the power wires into the correct screw clamps. Make sure the fuse block is installed properly for the given supply rating—120 or 240 Vac. The fuse is in the 120 Vac location from the factory.</p>
8	<p>Make sure the fuse block is installed in the proper location. Refer to Figure 2-9 for fuse block location.</p> <ul style="list-style-type: none"> • 120 Vac — Fuse block in location F2 • 240 Vac — Fuse block in location F1
9	<p>Dress the wires as slack as possible. This keeps the noise signal on these wires from bypassing built-in suppression. Also, do not bundle any low level signal wires with the power wires. Refer to Table 2-9 for permissible wire bundling.</p> <ul style="list-style-type: none"> • Refer to <i>Appendix B</i> for additional information concerning noise interference protection.
10	<p>Insert the wired plug into J10.</p> <p>WARNING Input line voltage will be present on the instrument ground plane if safety ground is not attached; personal injury and product damage could result.</p>

* ALL FIGURES AND TABLES REFER TO THE PRODUCT MANUAL.

WIRING

Figure 2-9*

AC Line Power Wiring

Factory Set 120 VAC.

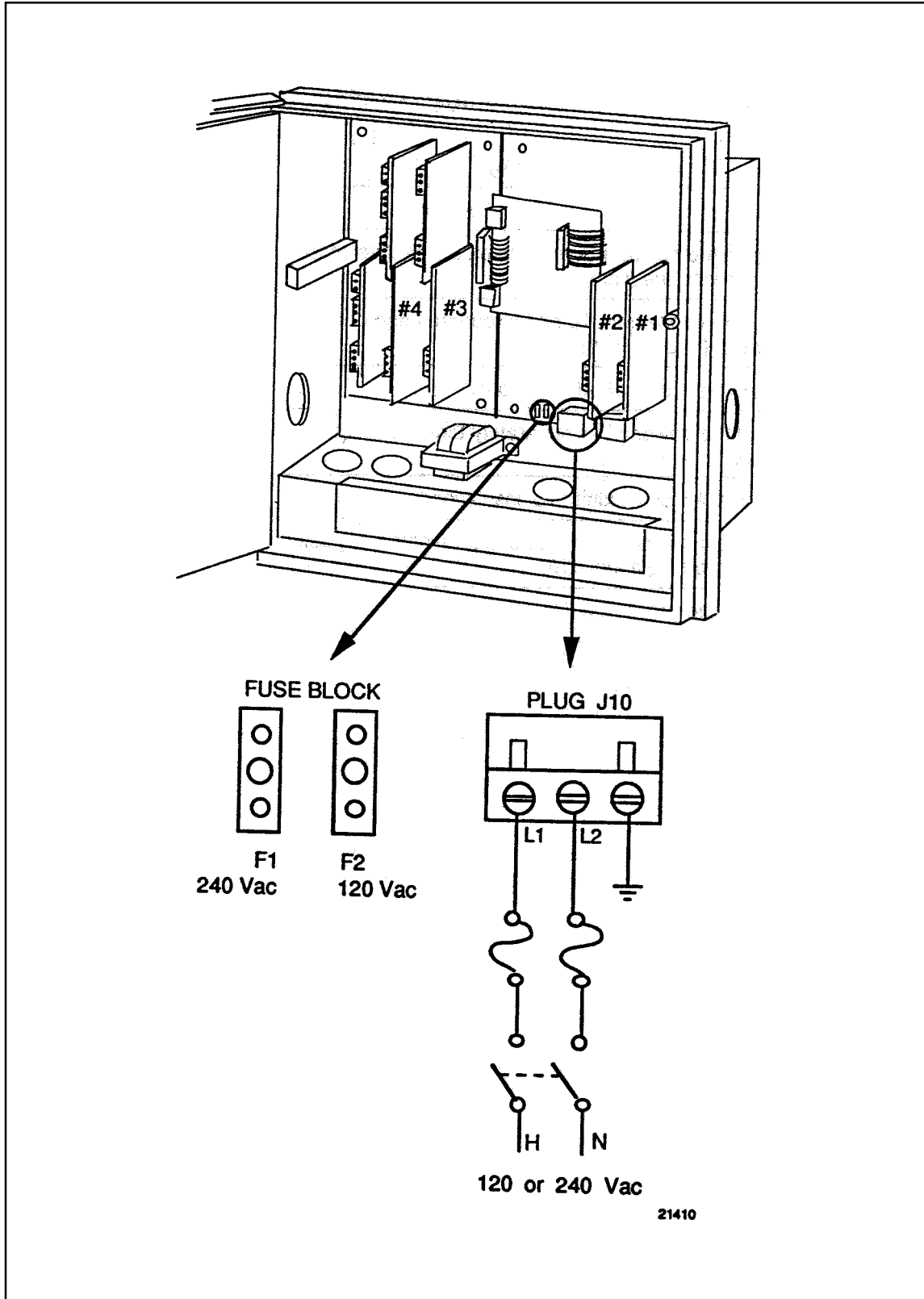

* ALL FIGURES AND TABLES REFER TO THE PRODUCT MANUAL.

WIRING DIAGRAM FOR IN48 CHART RECORDER - DUAL INPUTS TR15/16 TRANSMITTER 4-20 MA OUTPUT

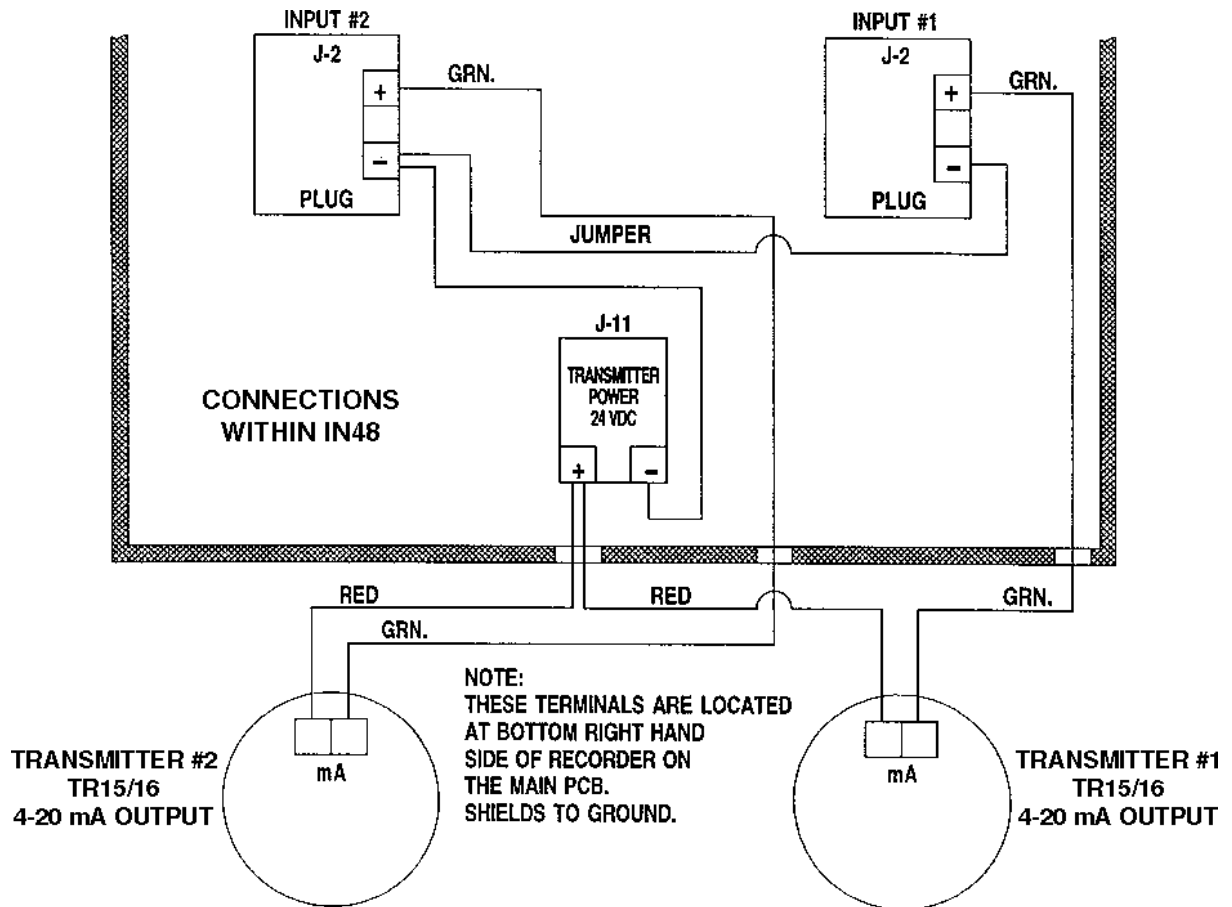

WIRING DIAGRAM FOR TR28 TO IN48 (FOR RECORDERS SOLD AFTER 5/93)

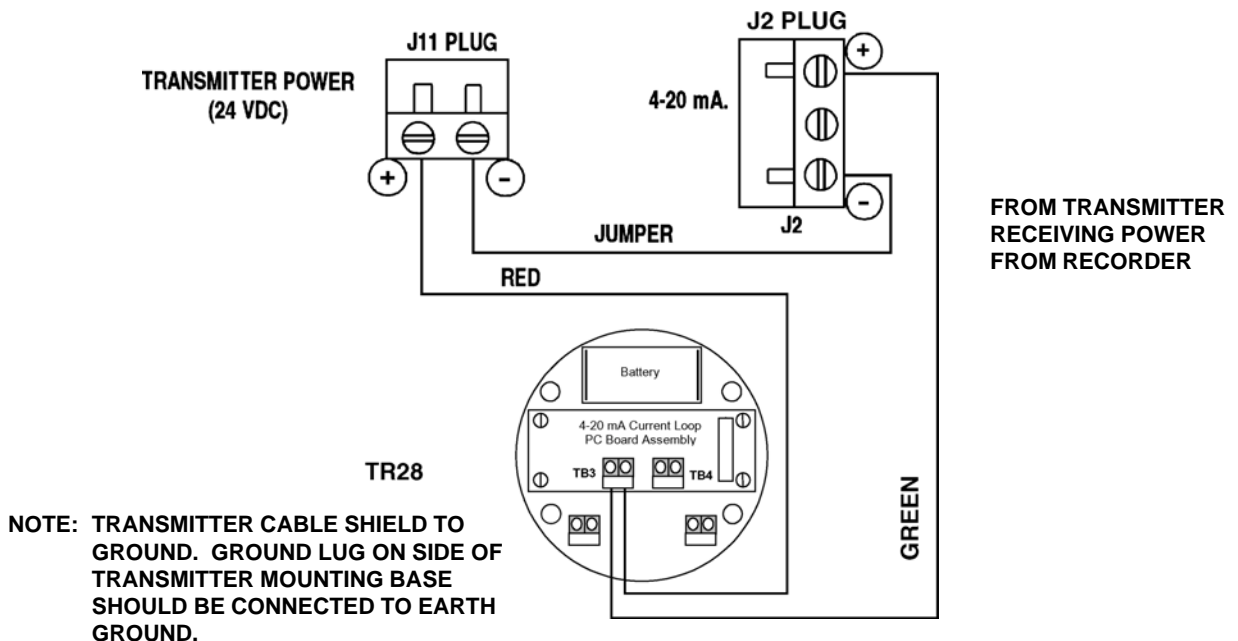

WIRING

4-20 mA Inputs and Transmitter Power

You can wire input 1, 2, 3, or 4 for 4-20 mA actuations.

The polarity for input #1, #2, #3, and #4 is identical.

The prerequisites are:

- Model Number - Table 1 = 1XXX, X1XX, XX1X, XXX1

ATTENTION Connector J11 on the main processor printed circuit board can be used to provide 24 Vdc power to up to two field transmitters (without power) which are supplying the 4-20 mA inputs signals to the recorder (1.2W @ Vdc = 50 mA available).

Refer to Figure 2-11 and follow the procedure in Table 2-12 to wire 4-20 mA inputs.

Table 2-12 4-20 mA Input Wiring

Step	Action
1	Open the recorder door. Loosen the captive screw in the chart plate and swing the plate out.
2	Be sure that the jumper is installed in the position labeled "MA"; this connects an internal 250 ohm resistor across the 4-20 mA input terminals on J2. (Refer to Figure 2-11 for location of jumper.)
3	Locate connector J2 on the printed circuit board for input 1. (Refer to Figure 2-11.)
4	Remove the unwired plug from J2.
5	Run the input wires through the desired knockout. DO NOT bundle them with the power wires.
6	Strip 1/4-inch maximum of insulation from the end of each wire.
7	Loosen the screws in plug J2 terminals and position the plug as you would to plug it into J2.
8	<ul style="list-style-type: none"> • For transmitters with power: Insert the wires into the appropriate screw clamps and tighten the screws to secure the wires. <p>ATTENTION The DR4500A Recorder inputs are protected from overvoltage by a protection diode. The wake up pulse on the ST3000 may not be recognized by the transmitter due to this clamping action. It may be necessary to add 100 ohms of additional loop resistance so the transmitter and SFC can communicate.</p> <ul style="list-style-type: none"> • For transmitters which require power: Remove the unwired plug from J11, then wire the transmitter power to J11 and the input to J2. Tighten the screws in the plugs to secure the wires.
9	Insert the wired plug into J2 and J11 as applicable.
10	Repeat steps 2 through 9 for input 2, 3, and 4 printed circuit boards as applicable.

* ALL FIGURES AND TABLES REFER TO THE PRODUCT MANUAL.

Figure 2-11* 4-20 mA Input Wiring
See Special Wire Drawing - Page 5

Factory Set.

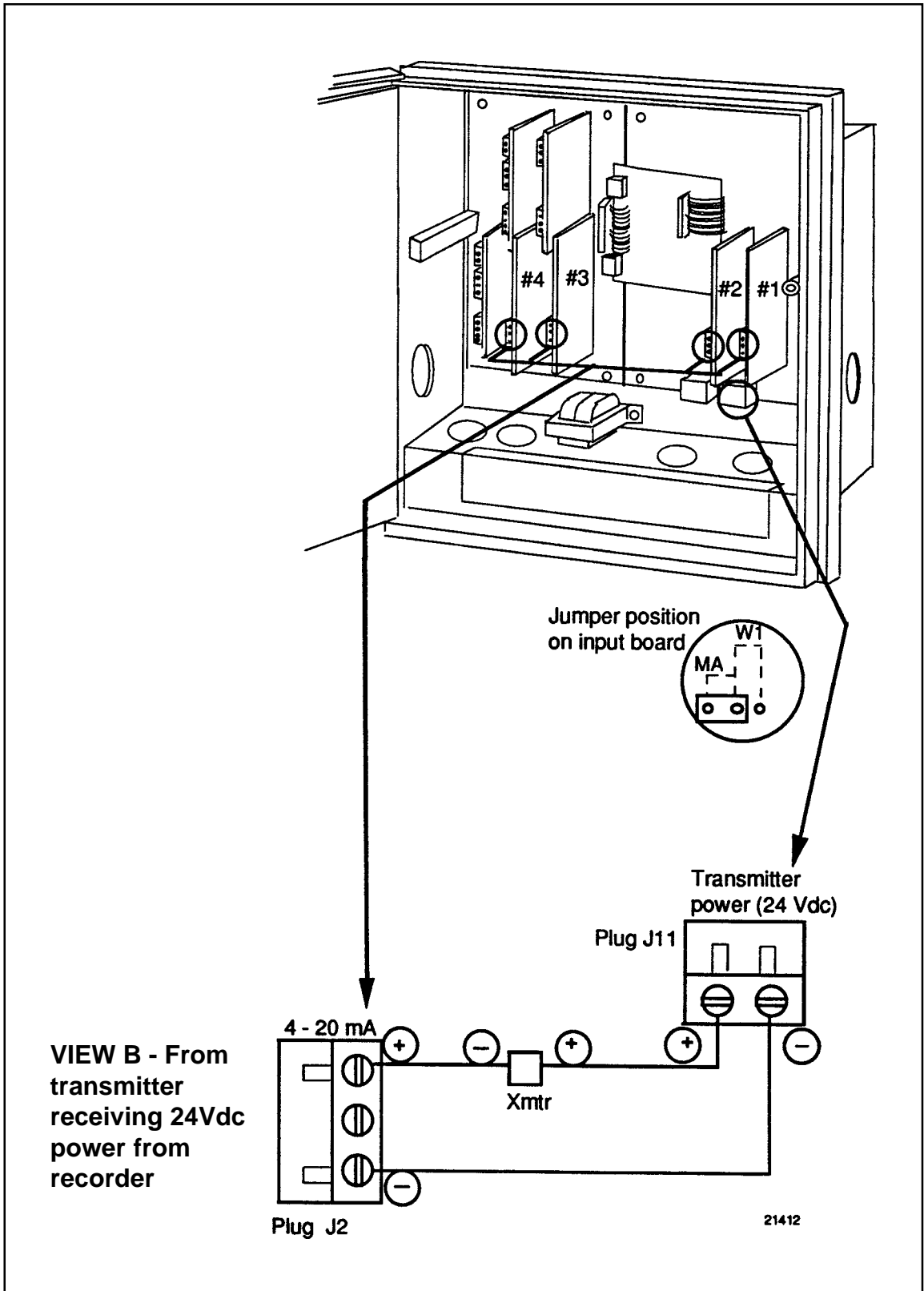

* ALL FIGURES AND TABLES REFER TO THE PRODUCT MANUAL.

STEPS FOR MAXIMIZING PEN LIFE

1. Store chart paper in a cool, clean dry place where temperature does not exceed 40°C (104°F) and humidity is below 65% RH.
2. Do not expose pen tip and chart paper to abrasive chemicals or dust that cause excessive pen wear.
3. If recorder is used in a dusty atmosphere, provide a positive clean air purge to minimize dust particle accumulation on chart paper.
4. Periodically clean pen arm using cotton swab dipped in alcohol. This is more important when recorder is located in a dusty environment and no clean air purge is used.
5. Never let pen tip ride on chart plate when paper is not present. Use pen lifter to raise arm when changing paper.
6. Keep door closed while recording.
7. Always insert pen arm tip in shipping sponge when storing or shipping recorder.
8. Be sure chart paper lays flat against chart plate. Any ripple in paper will cause light pen printing.
9. Be sure chart hub assembly is pushed onto motor shaft so it is flush with chart plate.

OPERATING THE RECORDER

1. Apply power and wait for recorder to run its power up tests. Allow recorder to warm up approximately 15 minutes.
2. Install the chart. Press the (chart) key. The pen will move to and stop at the outer limit of pen travel near the edge of the chart. Also chart rotation will stop and prompt (Cht. Hold) will appear in the lower display.
3. Pull the pen lifter up to raise the pen from the chart.
4. Carefully remove the used chart from the hub and retaining clips. (DO NOT REMOVE HUB ADAPTER.)
5. Install the new chart so that its edges are under the four retaining clips and its small alignment hole are over the alignment pin on the hub. (Press chart down completely around hub adapter.) DO NOT turn chart hub adapter. Recorder will turn hub adapter automatically.
6. Push the pen lifter down to lower pen.
7. Press the (chart) key. The prompt (CHT HOLD) in the lower display will be replaced by the parameter prompt value that was last selected using the (lower DISP) key.
8. Keep the door closed during operation to minimize dust accumulation on the chart.
9. To view the different inputs and totalizers use the (LOWR DISP) key.
10. Do not unplug the power to the recorder when the lockout mode is (NONE).

* ALL FIGURES AND TABLES REFER TO THE PRODUCT MANUAL.

DISPLAY AND KEY PAD DESCRIPTIONS

OPERATOR INTERFACE

Figure 1-1 shows the operator interface and defines the displays and indicators. The function of the keys is described in Table 1-1.*

Figure 1-1 Operator Interface

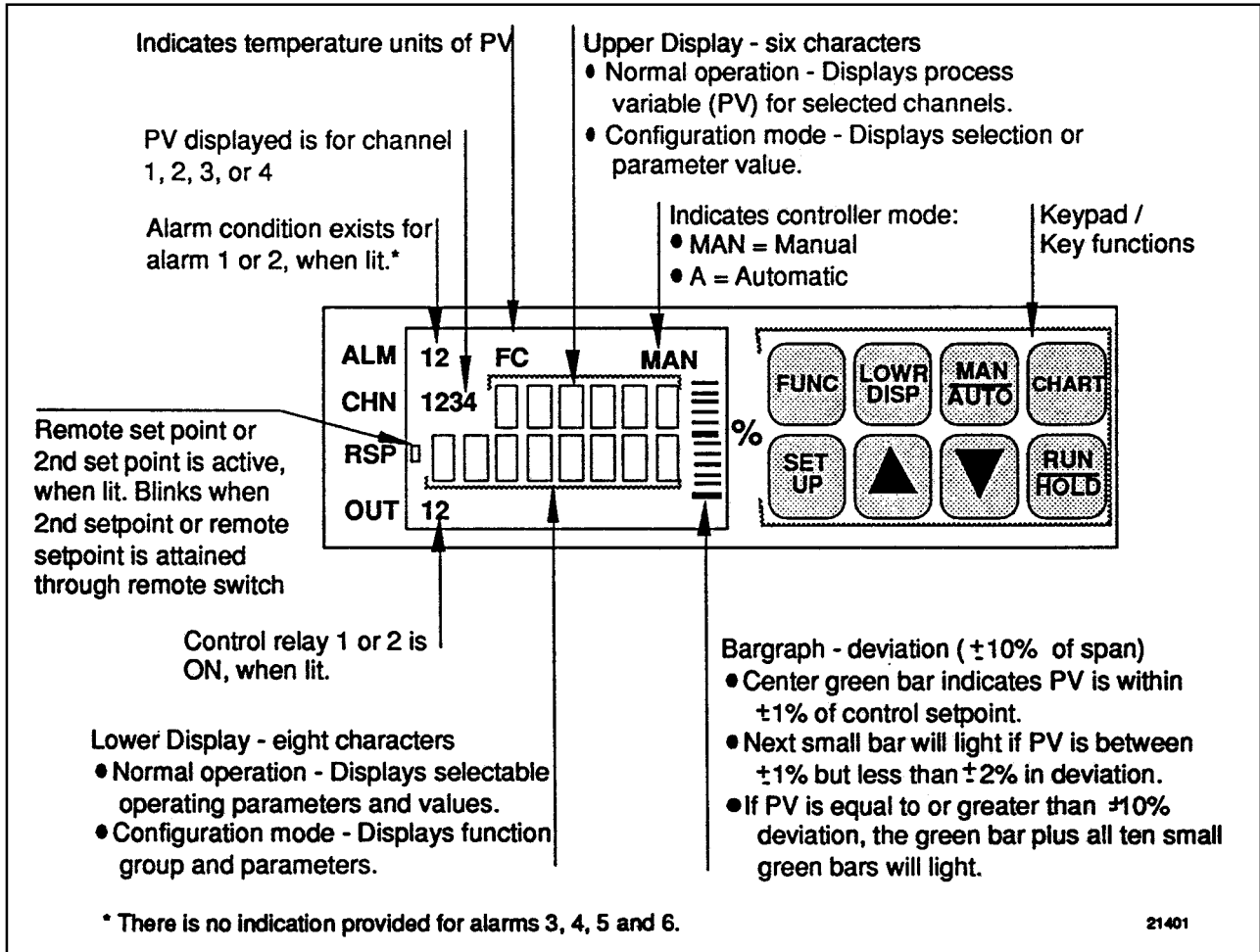



* ALL FIGURES AND TABLES REFER TO THE PRODUCT MANUAL.

KEY PAD DESCRIPTIONS

OPERATOR INTERFACE

Key Functions Table 1-1 shows each key on the operator interface and defines its function.

TABLE 1-1 FUNCTION OF KEYS

Key	Function																																													
SET UP	<ul style="list-style-type: none"> Places the controller in the Configuration Set Up select mode. Sequentially displays Set Up groups and allows the FUNC key to display individual functions in each Set Up group. 																																													
FUNC	<ul style="list-style-type: none"> Used in conjunction with the SET UP key to select the individual functions of a selected Configuration Set Up group. Used to toggle between SP1 and SP2. Used during field calibration procedure. 																																													
LOWR DISP	<ul style="list-style-type: none"> Selects and operating parameter to be shown in the lower display: <table style="margin-left: 20px; border: none;"> <tr><td>OUT</td><td>=</td><td>Output Value</td></tr> <tr><td>SP</td><td>=</td><td>Local Setpoint 1</td></tr> <tr><td>2SP</td><td>=</td><td>Local Setpoint 2</td></tr> <tr><td>RSP</td><td>=</td><td>Remote Setpoint</td></tr> <tr><td>2IN</td><td>=</td><td>Input 2</td></tr> <tr><td>3IN</td><td>=</td><td>Input 3</td></tr> <tr><td>4IN</td><td>=</td><td>Input 4</td></tr> <tr><td>DEV</td><td>=</td><td>Deviation</td></tr> <tr><td>EU</td><td>=</td><td>PV Engineering Units</td></tr> <tr><td>RH</td><td>=</td><td>% RH Value</td></tr> <tr><td>PIDSETX</td><td>=</td><td>Turning Parameter Set X=1 or 2</td></tr> <tr><td>RAMP</td><td>=</td><td>Minutes remaining in Setpoint Ramp</td></tr> <tr><td>#RA</td><td>=</td><td>Minutes remaining in SP Prog Ramp</td></tr> <tr><td>#SK</td><td>=</td><td>Minutes remaining in SP Prog Soak</td></tr> <tr><td>RECYC</td><td>=</td><td>Number of recycles left in SP Program.</td></tr> </table> <p style="margin-left: 20px;">ATTENTION The lower display can be configured to scroll through the operating parameters.</p>	OUT	=	Output Value	SP	=	Local Setpoint 1	2SP	=	Local Setpoint 2	RSP	=	Remote Setpoint	2IN	=	Input 2	3IN	=	Input 3	4IN	=	Input 4	DEV	=	Deviation	EU	=	PV Engineering Units	RH	=	% RH Value	PIDSETX	=	Turning Parameter Set X=1 or 2	RAMP	=	Minutes remaining in Setpoint Ramp	#RA	=	Minutes remaining in SP Prog Ramp	#SK	=	Minutes remaining in SP Prog Soak	RECYC	=	Number of recycles left in SP Program.
OUT	=	Output Value																																												
SP	=	Local Setpoint 1																																												
2SP	=	Local Setpoint 2																																												
RSP	=	Remote Setpoint																																												
2IN	=	Input 2																																												
3IN	=	Input 3																																												
4IN	=	Input 4																																												
DEV	=	Deviation																																												
EU	=	PV Engineering Units																																												
RH	=	% RH Value																																												
PIDSETX	=	Turning Parameter Set X=1 or 2																																												
RAMP	=	Minutes remaining in Setpoint Ramp																																												
#RA	=	Minutes remaining in SP Prog Ramp																																												
#SK	=	Minutes remaining in SP Prog Soak																																												
RECYC	=	Number of recycles left in SP Program.																																												
MAN AUTO	<ul style="list-style-type: none"> Alternately selects: <table style="margin-left: 20px; border: none;"> <tr> <td style="padding-right: 10px;">AUTO</td> <td>Lower display automatically displays setpoint value in engineering units.</td> </tr> <tr> <td>MAN</td> <td>Lower display automatically indicates output in %.</td> </tr> </table> 	AUTO	Lower display automatically displays setpoint value in engineering units.	MAN	Lower display automatically indicates output in %.																																									
AUTO	Lower display automatically displays setpoint value in engineering units.																																													
MAN	Lower display automatically indicates output in %.																																													
CHART	<ul style="list-style-type: none"> Used to stop printing operation and move pen to outer limit for chart change. Display will revert to date and time. 																																													
RUN HOLD	<ul style="list-style-type: none"> Alternate action switch initiates or holds the Setup Ramp or Setpoint Program. In configuration mode, restores the original value or selection if you do not want to enter a change you are making to a parameter. 																																													
	<ul style="list-style-type: none"> Increases the setpoint, output, or configuration values displayed. 																																													
	<ul style="list-style-type: none"> Decreases the setpoint, output, or configuration values displayed. 																																													

* ALL FIGURES AND TABLES REFER TO THE PRODUCT MANUAL.

ERROR MESSAGES

SELF DIAGNOSTICS

Error message prompts

Table 9-4

<i>Lower Display Indication</i>	<i>Test Group</i>	<i>Reason For Failure</i>	<i>How to Correct the Problem</i>
IN1RNG IN2RNG IN3RNG IN4RNG	Background	Input out of range. The process input is outside the range limits.	<ol style="list-style-type: none"> 1. Make sure the range and actuation are configured properly. 2. Check the input source. 3. Restore the factory calibration: <ol style="list-style-type: none"> a. Disconnect the wiring from the terminals on plug J2 on the input board. (See Figure 2-10.) Place a jumper across these terminals. The controller should read room temperature if it is configured for a thermocouple input. b. If it does not read room temperature, see <i>Section 3 - Configuration</i> and change the IN1TYP prompt in the INPUT 1 group to another type of thermocouple. c. After the change, press FUNC key, then the LOWER DISPLAY key. The controller should read the correct room temperature. If it does not, the unit has an input failure. d. Repeat step b. This time switch the IN1TYP back to the originally selected thermocouple. e. Repeat step c. The controller is restored with factory calibration. f. Remove the jumper and reconnect the thermocouple to plug J2. 4. Field calibrate. See <i>Section 7 - Input Calibration</i>. 5. Replace the input card. 6. Call Customer Support 1-800-423-9883 USA 1-800-461-0013 Canada

* ALL FIGURES AND TABLES REFER TO THE PRODUCT MANUAL.

ERROR MESSAGES

SELF DIAGNOSTICS

Error message prompts

Table 9-4

<i>Lower Display Indication</i>	<i>Test Group</i>	<i>Reason For Failure</i>	<i>How to Correct the Problem</i>
CAL Test (Note 1)	Power-up	The working calibration constants in the recorder are in error.	<ol style="list-style-type: none"> Change to a different input type. <ul style="list-style-type: none"> See <i>Section 3 - Configuration</i>. Check the "Device Status" (Table 9-3) to see if FACT CRC=PASS. <ul style="list-style-type: none"> If PASS—return to original input type. If FAIL—field calibrate. Refer to <i>Section 7 - Input Calibration</i>.
CAL1 ERR	Background	Working CAL TEST failure (Control 1, Input 1, Input 2).	<ol style="list-style-type: none"> Change to a different input type. <ul style="list-style-type: none"> See <i>Section 3 - Configuration</i>. Check "Device Status" (Table 9-3) to see if FACT CRC=PASS. <ul style="list-style-type: none"> If PASS—return to original input type. If FAIL—field calibrate Control Output #1, Input 1, or Input 2. Refer to <i>Section 7 - Input Calibration</i> and <i>Section 8 - Output Calibration</i>.
CAL2 ERR	Background	Working CAL TEST failure (Control 2, Output).	<ol style="list-style-type: none"> Field calibrate Control Output 2. <ul style="list-style-type: none"> Refer to <i>Section 8 - Output Calibration</i>.
FACT CRC	Check "Device Status." See Table 9-3.	Factory-set input constants have been changed due to the change in input type.	<ol style="list-style-type: none"> Check background test error message being displayed. Recalibrate Input or Output. <ul style="list-style-type: none"> Refer to <i>Section 7 - Input Calibration</i> or <i>Section 8 - Output Calibration</i>.
EE FAIL	Background	Unable to write to nonvolatile memory. Any time you change a parameter and it is not accepted, you will see EE FAIL.	<ol style="list-style-type: none"> Check the accuracy of the parameter and reenter. Try to change something in configuration. Call Customer Support 1-800-423-9883 USA 1-800-461-0013 Canada

NOTE 1: Will appear in "STATUS" Set Up Group—See Table 9-3

NOTE 2: Will also appear in rotation with other background test failure error messages.

* ALL FIGURES AND TABLES REFER TO THE PRODUCT MANUAL.

ERROR MESSAGES

SELF DIAGNOSTICS

Error message prompts

Table 9-4

<i>Lower Display Indication</i>	<i>Test Group</i>	<i>Reason For Failure</i>	<i>How to Correct the Problem</i>
IN1FAIL IN2FAIL IN3FAIL IN4FAIL	Background	Two consecutive failures of input 1 integration (for example, cannot make analog to digital conversion).	<ol style="list-style-type: none"> 1. Be sure the range and actuation are configured properly. 2. Check the input source. 3. Recalibrate. Refer to <i>Section 7 - Input Calibration</i>. 4. Replace the input card. 5. Call Customer Support 1-800-423-9883 USA 1-800-461-0013 Canada
BATTERY	Power-up or Status	Battery test failure.	<ol style="list-style-type: none"> 1. Replace battery. 2. Call Customer Support 1-800-423-9883 USA 1-800-461-0013 Canada
BATT LOW	Background		
PV LIMIT	Background	Process Variable is out of range. $\pm 10\%$ of range	<ol style="list-style-type: none"> 1. Be sure pen input configuration is correct. 2. Check the displayed PV value to see if it is outside limits. 3. Call Customer Support 1-800-423-9883 USA 1-800-461-0013 Canada
RV LIMIT	Background	The result of the formula shown below is beyond the range of the remote variable. $RV = INP2 \times RATIO + BIAS$	<ol style="list-style-type: none"> 1. Make sure the input signal is correct. 2. Make sure the ratio and bias settings are correct. 3. Go to CONTROL prompt REMOTE SOURCE and change REMOTE to 1LOCAL.

* ALL FIGURES AND TABLES REFER TO THE PRODUCT MANUAL.

ERROR MESSAGES

SELF DIAGNOSTICS

Error message prompts

The messages listed in Table 9-4 may appear during the power-up test or status test, or they may blink in the lower display as the result of ongoing background tests that verify data and memory integrity. In the case of more than one simultaneous malfunction in the background tests, only the one with the highest priority will appear in the lower display. Table 9-4 lists the error message, the test group that prompted the message, the reason for the failure, and how to correct the problem.

Table 9-4

<i>Lower Display Indication</i>	<i>Test Group</i>	<i>Reason For Failure</i>	<i>How to Correct the Problem</i>
FAILSAFE (Note 1) (Note 2)	Status or Background	This error message shows whenever the recorder goes into a failsafe mode of operation. This will happen if control is enabled and: <ul style="list-style-type: none"> • a power-up test fails, • a specific background test fails. (Failsafe will be displayed in rotation with other failure messages, except BATTERY, only if control is enabled.)	<ol style="list-style-type: none"> 1. Run through the "Device Status" check to determine the reason for the failsafe indication. See Table 9-3. 2. Identify the other failure message in the display and correct the problem according to the recommendations given in this table for that particular error message.
RAM TEST (Note 1)	Power-up	RAM failure	<ol style="list-style-type: none"> 1. Cycle power. 2. Check "Device Status" (Table 9-3) to see if error clears. 3. If error doesn't clear, replace the main printed circuit board.
CONFTEST (Note 1)	Power-up	Configuration data is in error.	<ol style="list-style-type: none"> 1. Check all the configuration prompts for accuracy. <ul style="list-style-type: none"> • See <i>Section 3 - Configuration</i> for selections and limits. 2. Change <i>any</i> configuration item, check "Device Status" to see if CONFTEST=PASS, return configuration item to original value. <ul style="list-style-type: none"> • See <i>Section 3 - Configuration</i> for instructions to change a configuration item.
CNFG ERR	Background	Configuration data is in error.	<ol style="list-style-type: none"> 1. Check all the configuration prompts for accuracy. <ul style="list-style-type: none"> • See <i>Section 3 - Configuration</i> for selections and limits. 2. Change <i>any</i> configuration item, then return it to the original value. <ul style="list-style-type: none"> • See <i>Section 3 - Configuration</i> for instructions to change a configuration item.

NOTE 1: Will appear in "STATUS" Set Up Group—See Table 9-3

NOTE 2: Will also appear in rotation with other background test failure error messages.

* ALL FIGURES AND TABLES REFER TO THE PRODUCT MANUAL.

SETTING START-UP (WAKE) TIME

PREREQUISITE:

LOCKOUT CONFIGURATION MUST BE CHANGED TO NONE. (SEE PAGE 22)

1. Press (SET UP) key until (CHART-SET UP) prompt appears in display.
2. Press (FUNC) key successively until (REM CHRT-NONE) appears.
3. Press (RAISE) or (LOWER) key until (REM CHRT-TIME) appears in display.
4. Press (SET UP) key until (SET UP-TIME) appears in display.
5. Press (FUNC) key successively until (WAKE MIN) prompt appears in display.
6. Press (RAISE) or (LOWER) key to set minutes for wake time. Setting range: (1-59)
7. Press (FUNC) key until (WAKE HR) prompt appears in display.
8. Press (RAISE) or (LOWER) key to set hours for wake time. Setting range: (1-23)
9. Press (FUNC) key until (WAKE-DAY) prompt appears in display.
10. Press (RAISE) or (LOWER) key to set day for wake time. Setting range: (1-31)
11. Press (FUNC) key until (WAKE-MON) prompt appears in display.
12. Press (RAISE) or (LOWER) key to set month for wake time. Setting range: (1-12)
13. Press (FUNC) key to enter present selection.
14. Press (LOWER DISP) to return to Operating Mode.

FOR MORE DETAILED INFORMATION, SEE PAGE 82 OF OWNER'S MANUAL

* ALL FIGURES AND TABLES REFER TO THE PRODUCT MANUAL.

CHANGING CHART RANGE

PREREQUISITE:

LOCKOUT CONFIGURATION MUST BE CHANGED TO NONE. (SEE PAGE 22)

1. Press (SET UP) key successively and call up (PEN 1) prompt in lower display.
2. Press (FUNC) key successively until (CHART 1 HI) appears in lower display. (If 2 inputs are used there will be a chart 2 HI and LO in the pen 2 configuration group.)
3. Use (RAISE) or (LOWER) key to set desired high range value for chart in upper display.
Setting Range: (-999.9 - 9999)
NOTE: If display blinks, you are trying to select an unacceptable value. You can change the value more quickly by holding in one key (RAISE) or (LOWER) and pressing the other one (LOWER) or (RAISE) at the same time. Adjustment will move one digit to the left with each press.
4. Press (FUNC) key until (CHART 1-LO) appears in lower display. (This will be needed to set chart low.)
5. Use (RAISE) or (LOWER) key to set desired low range value for chart in upper display.
Setting range: (-999.9 - 9999)
6. Press (FUNC) key successively until (RANGE 1 TAG) appears in lower display.
NOTE: For alphanumeric entries, the display will cycle from left to right, with highlighting (increased brightness) of each digit. The value of each digit can be changed only when it is highlighted.
7. Use (RAISE) or (LOWER) key to enter high scale range in upper display.
NOTE: You must also change (INPUT 1 HI) and (INPUT 1 LO) when changing range.
8. Press (SET UP) key until (INPUT 1) prompt appears in lower display.
9. Press (FUNC) key successively until (INPUT 1 HI) appears in lower display.
10. Use (RAISE) or (LOWER) key to set high range value for linear input.
Setting range: (-999.9 - 9999)
11. Press (FUNC) key until (INPUT 1 LO) prompt appears in lower display.
12. Use (RAISE) or (LOWER) key to set low range value for linear input.
Range: (-999.9 - 9999)
13. Press (FUNC) key to enter present selection.
14. Press (LOWER DISP) to return recorder to Operating Mode.

NOTE: If 2 inputs are used, repeat these procedures for pen 2.

15. To put back in Lockout Mode, see instructions on Enabling Lockout Mode on Page 22.

FOR MORE DETAILED INFORMATION, SEE PAGES 84 - 85 OF OWNER'S MANUAL

* ALL FIGURES AND TABLES REFER TO THE PRODUCT MANUAL.

CHANGING CHART SPEED

PREREQUISITE:

LOCKOUT CONFIGURATION MUST BE CHANGED TO NONE. (SEE PAGE 22)

1. Press (SET UP) key successively and call up (CHART) prompt in lower display.
2. Press (FUNC) key until (CHRT SPD) prompt appears in lower display.
NOTE: Hold key in if you want to scroll through all the function prompts associated with this group.
3. Use (RAISE) or (LOWER) key to select desired chart speed. Selections: (8HR, 24HR, 7DAYS, X-HR)
NOTE: If you select (X-HR), go to step 4; otherwise, go to step 6.
4. Press (FUNC) key to call up next parameter and enter present selection.
5. Use (RAISE) or (LOWER) key to set desired chart speed value in upper display or go to step 6.
Range (6-744 HRS)
6. Press (FUNC) key until (TIME DIV) prompt appears in lower display.
7. Use (RAISE) or (LOWER) key to set desired number of time periods into which chart record is to be divided.
Setting range: (8-24)
8. Press (FUNC) key to enter present selection.
9. Press (LOWER DISP) to return to Operating Mode.
10. To put back in Lockout Mode, see instructions on Enabling Lockout Mode, Page 22.

FOR MORE DETAILED INFORMATION, SEE PAGES 80 - 81 IN OWNER'S MANUAL.

* ALL FIGURES AND TABLES REFER TO THE PRODUCT MANUAL.

CHANGING TIME

PREREQUISITE:

LOCKOUT CONFIGURATION MUST BE CHANGED TO NONE. (SEE PAGE 22)

1. Press (SET UP) key successively and call up (TIME) prompt in lower display.
2. Press (FUNC) key until (MINUTES) prompt appears in lower display.
NOTE: Hold key in if you want to scroll through all the prompts associated with this group.
3. Use (RAISE) or (LOWER) key to set present time in minutes. Range: (1-59)
4. Press (FUNC) key until (HOURS) prompt appears in lower display.
5. Use (RAISE) or (LOWER) key to set hour in 24 HR clock format. Range: (1-23)
NOTE: If display blinks, you are trying to select an unacceptable value. You can change value more quickly by holding in one key (RAISE) or (LOWER) and pressing the other one (LOWER) or (RAISE) at the same time. Adjustment will move one digit to the left with each press.
6. Press (FUNC) key to enter present selection.
7. Press (LOWER DISP) key to return to Operating Mode.
8. To put back in Lockout Mode, see instructions on Enabling Lockout Mode, Page 22.

FOR MORE DETAILED INFORMATION, SEE PAGE 83 OF OWNER'S MANUAL.

RESETTING TOTALIZER

LOCKOUT:

THE LOCKOUT MODE IS USED TO KEEP UNQUALIFIED PERSONNEL FROM ENTERING CONFIGURATION MODE AND MAKING CHANGES OF CONFIGURATION.

PREREQUISITE:

LOCKOUT CONFIGURATION MUST BE CHANGED TO NONE. (SEE PAGE 22)

1. Press (SET UP) key successively until (TOTAL 1) prompt appears in display.
2. Press (FUNC) key successively until (RST TOT) prompt appears in display. (If 2 inputs are used there will be a chart 2 HI and LO in the pen 2 configuration group.)
3. Press (RAISE) or (LOWER) key to select YES to reset totalizer value to zero.
Selections: (YES - NO)
4. Press (FUNC) key to enter present selection.
5. Press (LOWER DISP) key to return recorder to operating mode.
NOTE: Totalizer (RSETABLE) prompt must be configured to (YES) before totalizer can be reset. It leaves the factory set for (YES).

NOTE: If the recorder has two totalizers, repeat these procedures for total (2) configuration.

6. To put back in Lockout Mode, see instructions on Enabling Lockout Mode, Page 22.

FOR MORE DETAILED INFORMATION, SEE PAGE 90-91 OF OWNER'S MANUAL

* ALL FIGURES AND TABLES REFER TO THE PRODUCT MANUAL.

CONFIGURATION RECORD SHEET

Keep a Record

Enter the value or selection for each prompt on this sheet so you will have a record of how your recorder was configured.

<i>Group Prompt</i>	<i>Function Prompt</i>	<i>Value or Selection</i>	<i>Factory Setting</i>	<i>Group Prompt</i>	<i>Function Prompt</i>	<i>Value or Selection</i>	<i>Factory Setting</i>	
TUNING 1	PROP BD	_____	1.0	CHART	CHRTSPD	_____	XHR	
	or				HOUR/REV	_____	12	
	GAIN	_____	1.0		TIME DIV	_____	24	
	RATE MIN	_____	0.00		CONTINUE	_____	NO	
	RSET MIN	_____	1.0		CHART NAM	_____	TRULIN	
	or				HEADER	_____	NO	
	RSET RPM	_____	1.0		REMSW	_____	NONE	
	or				WAKEMIN	_____	0	
	MAN RSET	_____	0.0		WAKE HR	_____	0	
	CYCSEC	_____	20.0		WAKE DAY	_____	0	
	PROP BD2	_____	1.0		WAKE MON	_____	0	
	or				TIME	MINUTES	_____	Set
	GAIN 2	_____	1.0			HOURS	_____	to
	RATE2MIN	_____	0.00			DAY	_____	local
	RSET2MIN	_____	1.0	MONTH		_____	time	
	or			YEAR		_____		
RSET2PRM	_____	1.0	DAY	_____				
CYC2SEC	_____	20.0						
TUNING 2	PROP BD	_____	1.0	PEN 1	PEN 1	_____	ENABLE	
	or				PEN1IN	_____	INPUT1	
	GAIN	_____	1.0		CHART1HI	_____	302.0	
	RATE MIN	_____	0.00		CHART1LO	_____	292.0	
	RSET MIN	_____	1.0		PEN1ON	_____	91.0	
	or				PEN1OFF	_____	93.0	
	RSET RPM	_____	1.0		MAJORDIV	_____	10	
	or				MINORDIV	_____	10	
	MAN RSET	_____	0.0	RNG1TAG	_____	RNG1		
	CYCSEC	_____	20.0	PEN 2	PEN 2	_____	ENABLE	
	PROP BD2	_____	1.0		PEN2IN	_____	INPUT2	
	or				CHART2HI	_____	302.0	
	GAIN 2	_____	1.0		CHART2LO	_____	292.0	
	RATE2MIN	_____	0.00		PEN2ON	_____	91.0	
	RSET2MIN	_____	1.0		PEN2OFF	_____	93.0	
	or				MAJORDIV	_____	10	
RSET2PRM	_____	1.0	MINORDIV		_____	10		
CYC2SEC	_____	20.0	RNG2TAG	_____	RNG2			
SP RAMP1	SP RAMP	_____	DISABL	PEN 3	PEN 3	_____	ENABLE	
	TIME MIN	_____	0		PEN3IN	_____	INPUT3	
	FINAL SP	_____	100.00		CHART3HI	_____	302.0	
	SP RATE	_____	0		CHART3LO	_____	292.0	
	EU/HR UP	_____	0		PEN3ON	_____	91.0	
	EU/HR DN	_____	0		PEN3OFF	_____	93.0	
	SP PROG	_____	DISABL		MAJORDIV	_____	10	
SP RAMP2	SP RAMP	_____	DISABL	MINORDIV	_____	10		
	TIME MIN	_____	0	RNG3TAG	_____	RNG3		
	FINAL SP	_____	100.0					
	SP RATE	_____	0					
	EU/HR UP	_____	0					
	EU/HR DN	_____	0					
	SP PROG	_____	DISABL					

* ALL FIGURES AND TABLES REFER TO THE PRODUCT MANUAL.

CONFIGURATION RECORD SHEET

Group Prompt	Function Prompt	Value or Selection	Factory Setting	Group Prompt	Function Prompt	Value or Selection	Factory Setting
PEN 4	PEN 4	_____	ENABLE	INPUT 4	DECIMAL	_____	XXX.X
	PEN4IN	_____	INPUT4		UNITS	_____	DEGF
	CHART4HI	_____	302.0		ENGUNITS	_____	0
	CHART4LO	_____	292.0		IN4 TYPE	_____	100PT
	PEN4ON	_____	91.0		XMITTER	_____	LINEAR
	PEN4OFF	_____	93.0		IN4 HI	_____	900
	MAJORDIV	_____	10		IN4 LO	_____	-300
	MINORDIV	_____	10		CUTOFF 4	_____	0
INPUT 1	RNG4TAG	_____	RNG4	INPTCOMP	_____	0	
	DECIMAL	_____	XXX.X	FILTER 4	_____	0	
	UNITS	_____	DEGF	BURNOUT	_____	UP	
	ENGUNITS	_____	0	TOTAL 1	(Value)	_____	E0 GAL
	IN1 TYPE	_____	100PT	RSETTOT	_____	NO	
	XMITTER	_____	LINEAR	TOTAL 1	_____	DISABL	
	IN1 HI	_____	900	TOTALEU	_____	GAL	
	IN1 LO	_____	-300	RATE	_____	SECOND	
INPUT 2	CUTOFF 1	_____	0	SCALER	_____	1	
	INPTCOMP	_____	0	RSETABLE	_____	NO	
	FILTER 1	_____	0	TOTAL 2	(Value)	_____	E0 GAL
	BURNOUT	_____	UP	RSETTOT	_____	NO	
	DECIMAL	_____	XXX.X	TOTAL 2	_____	DISABL	
	UNITS	_____	DEGF	TOTALEU	_____	GAL	
	ENGUNITS	_____	0	RATE	_____	SECOND	
	IN2 TYPE	_____	100PT	SCALER	_____	1	
INPUT 3	XMITTER	_____	LINEAR	RSETABLE	_____	NO	
	IN2 HI	_____	900	CONTROL 1	PID SETS	_____	1ONLY
	IN2 LO	_____	-300	SW VALUE	_____	0.0	
	CUTOFF 2	_____	0	SP SOURC	_____	1LOCAL	
	INPTCOMP	_____	0	RATIO	_____	1.0	
	FILTER 2	_____	0	BIAS	_____	0	
	BURNOUT	_____	UP	SP TRACK	_____	NONE	
	DECIMAL	_____	XXX.X	POWER UP	_____	MANUAL	
INPUT 4	UNITS	_____	DEGF	SP HILIM	_____	500	
	ENGUNITS	_____	0	SP LOLIM	_____	0	
	IN3 TYPE	_____	100PT	ACTION	_____	REVERSE	
	XMITTER	_____	LINEAR	OUT HILIM	_____	100.0	
	IN3 HI	_____	900	OUT LOLIM	_____	0	
	IN3 LO	_____	-300	DROPOFF	_____	0.0	
	CUTOFF 3	_____	0	DEADBAND	_____	2.0	
	INPTCOMP	_____	0	OUT HYST	_____	0.5	
	FILTER 3	_____	0	FAILSAFE	_____	50	
	BURNOUT	_____	UP	REM SW	_____	NONE	
				MAN KEY	_____	ENABLE	
				PBorGAIN	_____	GAIN	
				MINorRPM	_____	MIN	
				CONT1ALG	_____	PIDA	
				OUT1ALG	_____	CURRENT	
				4-20 RNG	_____	50PCT	
			SHEDMODE	_____	LAST		
			SHED SP	_____	TOLSP		

* ALL FIGURES AND TABLES REFER TO THE PRODUCT MANUAL.

CONFIGURATION RECORD SHEET

Group Prompt	Function Prompt	Value or Selection	Factory Setting	Group Prompt	Function Prompt	Value or Selection	Factory Setting	
CONTROL 2	PID SETS	_____	1ONLY	ALARMS	A1S1 VAL	_____	90	
	SW VALUE	_____	0.0		A1S2 VAL	_____	95	
	SP SOURC	_____	1LOCAL		A1S1TYPE	_____	INPUT1	
	RATIO	_____	1.0		A1S2TYPE	_____	INPUT1	
	BIAS	_____	0		A1S1 H L	_____	LO	
	SP TRACK	_____	NONE		A1S1 EV	_____	0	
	POWER UP	_____	MANUAL		A1S2 H L	_____	HI	
	SP HILIM	_____	500		A1S2 EV	_____	0	
	SP LOLIM	_____	0		A2S1 VAL	_____	80	
	ACTION	_____	REVERSE		A2S2 VAL	_____	85	
	OUT HILIM	_____	100.0		A2S1TYPE	_____	INPUT2	
	OUT LOLIM	_____	0		A2S2TYPE	_____	INPUT2	
	DROPOFF	_____	0.0		A2S1 H L	_____	LO	
	DEADBAND	_____	2.0		A2S1 EV	_____	0	
	OUT HYST	_____	0.5		A2S2 H L	_____	HI	
	FAILSAFE	_____	50		A2S2 EV	_____	0	
	REM SW	_____	NONE		AL HYST	_____	0.1	
	MAN KEY	_____	ENABLE		EVENT MSG	EVENT 1	_____	NONE
	PBorGAIN	_____	GAIN			MESSAGE1	_____	EVENT1
	MINorRPM	_____	MIN			POSITION1	_____	87.3
CONT1ALG	_____	PIDA	EVENT 2	_____		NONE		
OUT1ALG	_____	CURRENT	MESSAGE2	_____		EVENT2		
4-20 RNG	_____	50PCT	POSITION2	_____		85.5		
SHEDMODE	_____	LAST	EVENT 3	_____		NONE		
SHED SP	_____	TO LSP	MESSAGE3	_____		EVENT3		
OPTIONS	INPUT 1	_____	ENABLE	POSITION3		_____	83.6	
	INPUT 2	_____	ENABLE	EVENT 4		_____	NONE	
	INPUT 3	_____	ENABLE	MESSAGE4		_____	EVENT4	
	INPUT 4	_____	ENABLE	POSITION4		_____	80.0	
	CONTROL 1	_____	ENABLE	EVENT 5		_____	NONE	
	CONTROL 2	_____	ENABLE	MESSAGE5		_____	EVENT5	
	REJ FREQ	_____	60	POSITION5		_____	78.2	
	AUX OUT	_____	DISABL	EVENT 6		_____	NONE	
	4 mA VAL	_____	0.0	MESSAGE6	_____	EVENT6		
	20mA vAL	_____	100.0	POSITION6	_____	76.9		
	HF REJ	_____	ENABLE	LOCKOUT	PASSWORD	_____	XXXX	
	RELHUMID	_____	NO		LOCKOUT	_____	CALIB	
	ATMPRES	_____	0		CHANGE	_____	XXXX	
	DEVIATION	_____	NONE	ADJUST	TRACE LN	_____	MEDIUM	
	DEVSETPT	_____	0		GRID LN	_____	MEDIUM	
	SCROLL	_____	NONE		PEN TYPE	_____	NORMAL	
	INP ALG	_____	NONE					
	COEFF	_____	1.0					
	PV HIGH	_____	0.0					
	PV LOW	_____	0.0					
	RATIO A	_____	1.0					
	BIAS A	_____	0.0					
	RATIO B	_____	1.0					
	BIAS B	_____	0.0					
	RATIO C	_____	1.0					
	BIAS C	_____	0.0					
	GRANDTOT	_____	DISABL					
	ComSTATE	_____	DISABL					
	ComADDR	_____	0					
	SHEDTIME	_____	0					
	UNITS	_____	PERCENT					

* ALL FIGURES AND TABLES REFER TO THE PRODUCT MANUAL.

ENABLING AND DISABLING LOCKOUT MODE[‡]

LOCKOUT:

THE LOCKOUT MODE IS USED TO KEEP UNQUALIFIED PERSONNEL FROM ENTERING CONFIGURATION MODE AND MAKING CHANGES OF CONFIGURATION.

ENABLING LOCKOUT MODE:

1. Press (SET UP) key until (LOCKOUT-SET UP) appears on display.
2. Press (FUNC) key until (PASSWORD) appears.
3. When each unit is highlighted, press (RAISE) key to enter code (3544).
4. Press (FUNC) key until (LOCKOUT-NONE) appears.
5. Press (RAISE) or (LOWER) key to change to (LOCKOUT-MAX).
6. Press (FUNC) key to enter present selection.
7. Press (LOWER DISP) to return to Operating Mode.

DISABLING LOCKOUT MODE:

1. You must enter the Lockout Code (3544) and enter Lockout Configuration Mode.
2. Press (SET UP) key until (SET UP-LOCKOUT) appears on display.
3. Press (FUNC) key until (PASSWORD) appears.
4. When each unit is highlighted, press the (RAISE) key until the code (3544) is entered.
5. Press (FUNC) key, you are in Lockout Configuration Mode. (LOCKOUT-MAX) appears on display.
6. Press (RAISE) or (LOWER) key until display reads (LOCKOUT-NONE).
7. Press (FUNC) key to enter present selection.
8. Press (LOWER DISP) key to return to Operating Mode.
9. To put back in Lockout Mode, see instructions on Enabling Lockout Mode.

‡ NOTE: All recorders are preset with lockout code 3544. You may change the lockout code if desired.

FOR MORE DETAILED INFORMATION, SEE PAGE 69 IN OWNER'S MANUAL.

* ALL FIGURES AND TABLES REFER TO THE PRODUCT MANUAL.

INDEX

CHANGING CHART RANGE	16
CHANGING CHART SPEED	17
CHANGING TIME	18
CONFIGURATION RECORD	19 - 21
DISPLAY AND KEY PAD DESCRIPTIONS	9
ENABLING AND DISABLING LOCKOUT	22
ERROR MESSAGES	11 - 14
KEY PAD DESCRIPTIONS	10
OPERATING THE RECORDER	8
RESETTING THE TOTALIZER	18
SETTING START UP TIME	15
STEPS FOR MAXIMIZING PEN LIFE	8
WIRING	3 - 7
WIRING DIAGRAM	5

* ALL FIGURES AND TABLES REFER TO THE PRODUCT MANUAL.

