

*Flow measurement
solutions for
water and
wastewater*

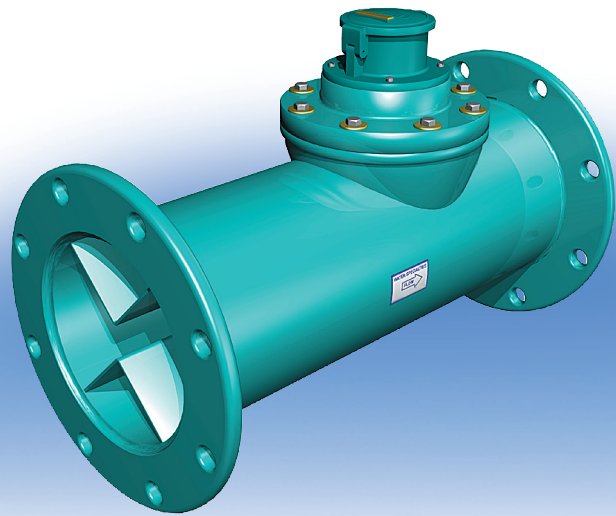

Propeller Meters



PROPELLER METERS

Perfect flow measurement solutions

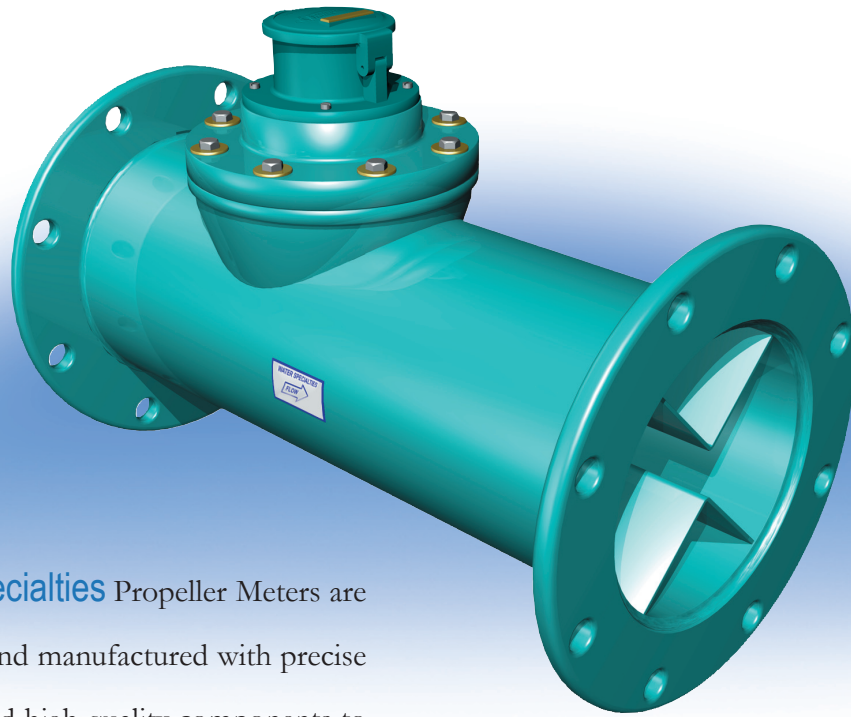

Water Specialties Propeller Meters are designed and manufactured with precise techniques and high quality components to deliver superior performance, low maintenance and unsurpassed durability. Materials used on all meters and flow ranges for low velocity construction meet or exceed AWWA standard C704-02. Meters are available for a variety of applications, in sizes 2" through 120".

Potable water

Wastewater management

Water well production

Marine system testing

Fire sprinkler testing

Pumping stations

Truck loading and discharge

Canal laterals

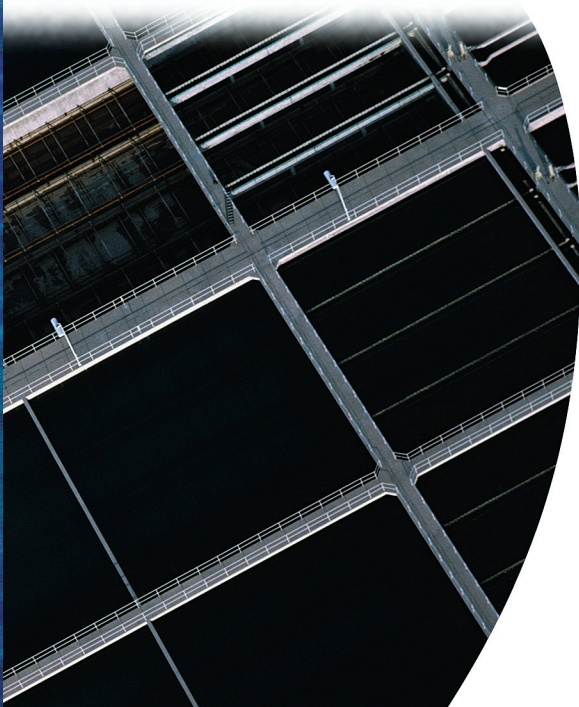

Quality design, superior performance

Optional FlowCom digital indicator-totalizer has a non-volatile memory. The five digit indicator shows flow rate in 22 different units, including GPM, CFS, MGD. The eight digit totalizer provides volumetric flow data and is available in 20 different units, including Gallons, AF, CF. Units of measurement are user-selectable. Battery life is 6-10 years. Housing is NEMA 4X rated. Available with optional 4-20mA and/or pulse output.



Optional indicator-totalizer delivers instantaneous flow rate indication and totalization of flow volume. 4-inch diameter display with 250° dial, six-digit totalizer, and test sweep hand. Configurable in GPM, CFS, MGD or any standard liquid measuring units. Choice of standard totalizer measuring units. Available with optional 4-20mA and/or pulse output.

Injection molded thermoplastic bonnets.

Hinged lid with padlock hasp to prevent unauthorized entry.

Fabricated steel meter tubes with

straightening vanes. Coated inside and out with 12 – 15 mils of NSF approved fusion-bonded epoxy.

Cast iron or fabricated steel meter heads

feature a protective 12- to 15-mil coating of NSF approved fusion-bonded epoxy.

Long life ceramic dual thrust bearings handle both forward and reverse direction flow.

Water-lubricated ceramic sleeve propeller bearing rides on a ceramic sleeved stainless steel spindle.

Injection molded propeller designed to handle temperatures up to 140° without pitch distortion. Also available for temperatures up to 350°.

Four-pole radial, permanent ceramic type magnetic drive will not demagnetize or rust.

Oil-filled, sealed gearbox houses miter gears suspended between stainless steel ball bearings for smoother operation.





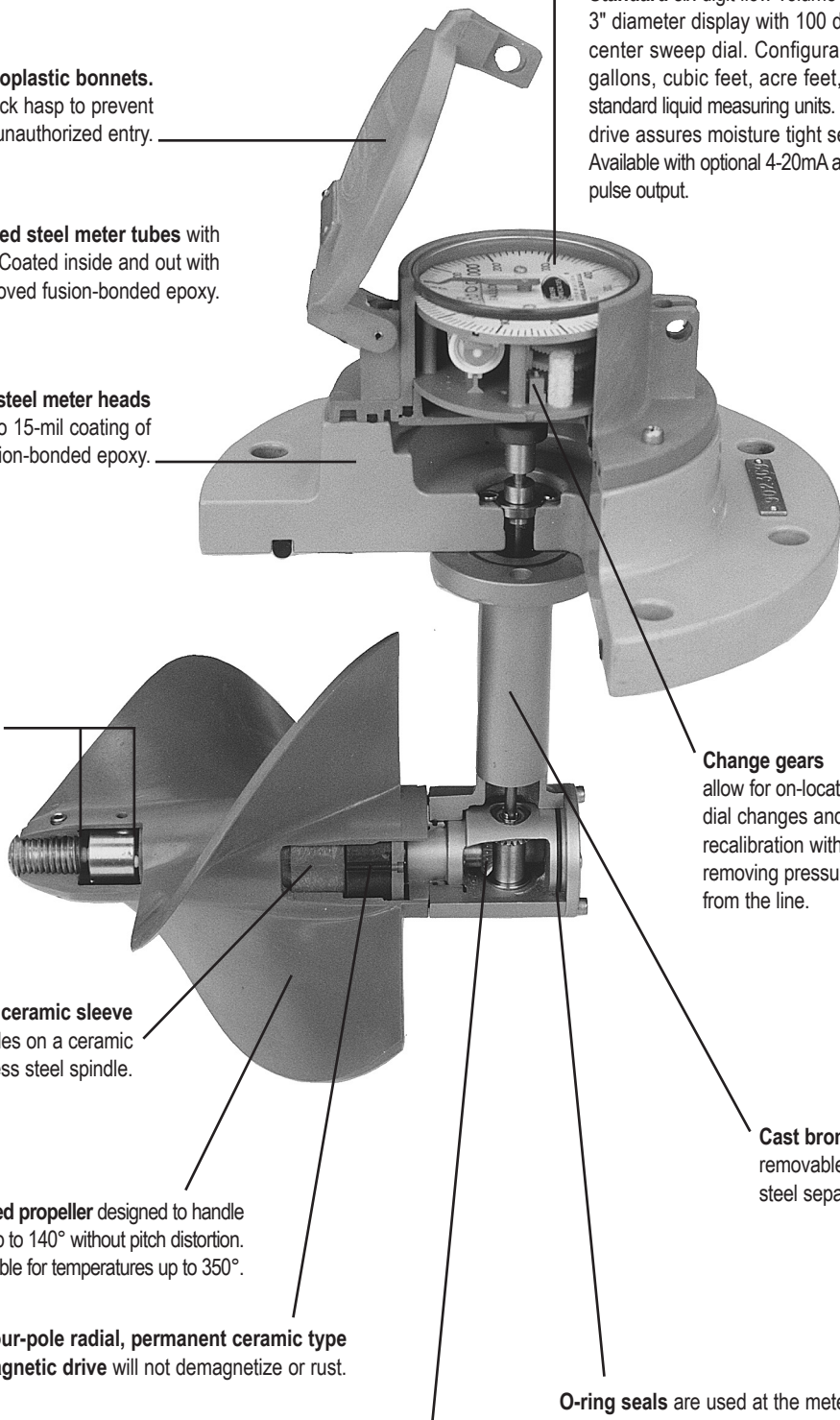

Standard six-digit flow volume totalizer. 3" diameter display with 100 division center sweep dial. Configurable in gallons, cubic feet, acre feet, or any standard liquid measuring units. Magnetic drive assures moisture tight seal. Available with optional 4-20mA and/or pulse output.

Change gears allow for on-location dial changes and recalibration without removing pressure from the line.

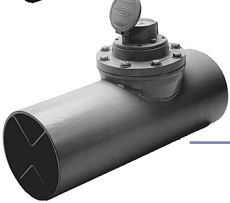
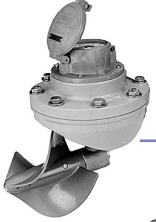
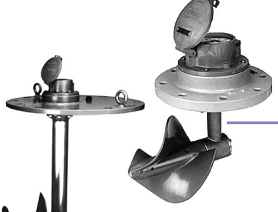
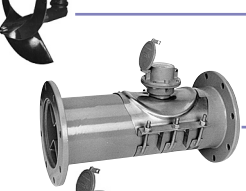
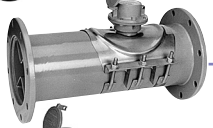
Cast bronze gearbox with removable one-piece stainless steel separator/spindle.

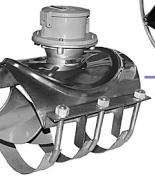
O-ring seals are used at the meter head and all other points where seals are required.



		Model no.	Pressure rating	Standard totalizer	Indicator/totalizer	Digital	Installation notes			
	2" - 48"	Steel flanged-end tube meter	ML03	150 PSI	✓					
			ML04	150 PSI		✓				
			ML04D	150 PSI			✓			
			ML07	300 PSI	✓					
			ML08	300 PSI		✓				
	3" - 48"	Steel plain-end tube meter	ML11	150 PSI	✓		••			
			ML12	150 PSI		✓	••			
			ML12D	150 PSI			✓	••		
			ML15	300 PSI	✓			••		
			ML16	300 PSI		✓		••		
	4" - 72"	Steel welding saddle meter	ML19	150 PSI	✓		•••			
			ML20	150 PSI		✓	•••			
			ML20D	150 PSI			✓	•••		
			ML21	300 PSI	✓			•••		
			ML22	300 PSI		✓		•••		
	3" - 72"	Meter head assembly	MLT1	150 PSI *	✓		•			
			MLI1	150 PSI *		✓	•			
			MLI1D	150 PSI *			✓	•		
				16" - 120"	Manhole meter	ML23	150 PSI	✓		
						ML24	150 PSI		✓	
ML24D	150 PSI						✓			
	4" - 16"	Steel flanged-end tube meter	LP03	150 PSI	✓					
			LP04	150 PSI		✓				
			LP04D	150 PSI			✓			
	4" - 12"	Steel plain-end tube meter	LP11	150 PSI	✓		••			
			LP12	150 PSI		✓	••			
			LP12D	150 PSI			✓	••		
	4"	Strap-on saddle meter DUCTILE IRON SADDLE	LP21	150 PSI	✓		•••			
			LP22	150 PSI		✓	•••			
			LP22D	150 PSI			✓	•••		
	6" - 20"	Strap-on saddle meter STAINLESS STEEL SADDLE	LP31	150 PSI	✓		•••			
			LP32	150 PSI		✓	•••			
			LP32D	150 PSI			✓	•••		
	4" - 20"	Vertical upflow meter	VF27	150 PSI	✓		○			
			VF28	150 PSI		✓	○			
			VF28D	150 PSI			✓	○		
	4" - 20"	Vertical downflow meter	VF31	150 PSI	✓		○			
			VF32	150 PSI		✓	○			
			VF32D	150 PSI			✓	○		
	4" - 20"	Vertical upflow tee-tube meter	VF29	150 PSI	✓		○○			
			VF30	150 PSI		✓	○○			
			VF30D	150 PSI			✓	○○		
	10" - 72"	Open flow meter	OF11	150 PSI	✓		○○○			
			OF12	150 PSI		✓	○○○			
			OF12D	150 PSI			✓	○○○		

* Available for 300 PSI applications. Replacement meter heads available for other brands of meters.

NOTE Consult factory for special pressure ratings or materials of construction.

Remote mounting

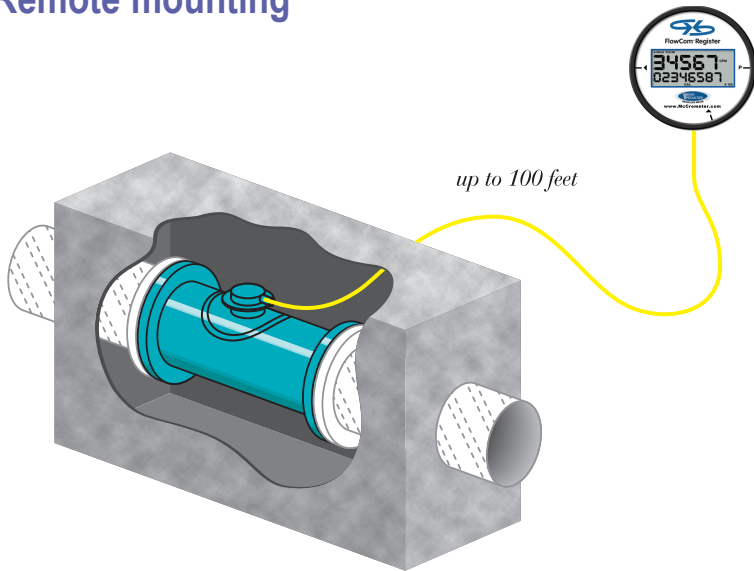

The Remote Mounting Kit is the ideal solution for measuring flows in tight-fit installations, such as meter vaults or confined spaces. Designed for use with FlowCom digital indicator-totalizers and indicator-totalizer-transmitters, the kit includes a water-tight connection to the meter head, and up to 100 feet of cable. All parts are constructed of durable, corrosion-resistant materials for a long maintenance-free life.

Installation notes

- Meters bolt into existing Water Specialties saddles or meter tubes.
- Installation is made by using one of many types of pipe couplings available or by welding to adjoining pipe.
- Installation is made by cutting a hole in the existing pipe and then attaching meter securely to the line.
 - Installation is made to an appropriate cast iron or fabricated tee. Replace an elbow in existing systems, such as on the suction side of a centrifugal pump or laterals in irrigation systems.
 - Installation is made to any vertical discharge line with the proper size flange connection, or to vertical discharge concrete turnouts with proper anchor bolts.
 - Installation is made to any wall or vertical structure which will center the propeller in the measuring area. For use in ditch turnouts, reservoir outlets, closed conduits, or other similar installations that have a controlled flow measuring area and full flow of liquid.

Electronic propeller meters

Water Specialties offers the most radical change in propeller meters in the last fifty years. Our electronic meter offers the latest in technology and simplicity of design. Engineered from the ground up, the electronic meter is light years ahead of its time.

One moving part

The propeller is the only moving part in the electronic propeller meter. A sensor which is magnetically coupled to the propeller electronically drives the digital indicator-totalizer.

FlowCom display

Specially designed LCD display can be read in bright sunlight and will not be damaged by prolonged exposures to sunlight. The indicator-totalizer is encapsulated in a moisture resistant barrier so no moisture can come in contact with the electronic components. This solid state design offers extended life.

Long life battery

The battery has a life of 6 to 10 years.

Transmitter Optional Outputs

- 4-20 mA
- Pulse output
- Contact closure

Memory

The non-volatile memory retains the totalizer quantity and programming.

Installation

The electronic meters can be installed vertically, horizontally or inclined.

Conversion

Water Specialties mechanical propeller meters can be converted to electronic propeller meters in the field.

Transmitters

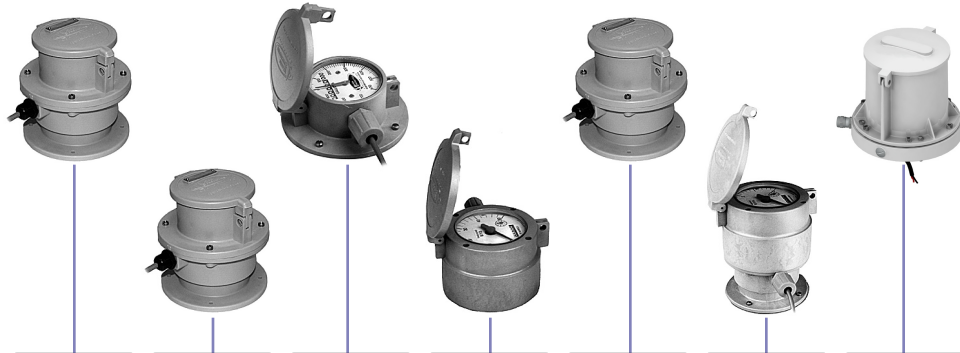

	TR01-1		TR01-1-150		TR01-1-30		TR04-2		TR15		TR16		FC101		
Totalizer	TR01-1		TR01-1-150		TR01-1-30		TR04-2		TR15		TR16		FC101		
Indicator-totalizer	TR06-1		TR06-1-150		TR06-1-30				TR12-2		TR16		FC101		
LCD display													✓		
Solid-state construction	✓	✓							✓		✓		✓		
Optic	✓	✓							✓		✓				
Magnetic actuated reed			✓	✓	✓	✓	✓		✓		✓				
PULSE RATE OUTPUT															
2-wire circuit			150 PPM				✓		✓		150–600 PPM		150–600 PPM		✓
3-wire circuit	600 or 1200 PPM				30 PPM										
CURRENT OUTPUT															
4 – 20 mA									✓		✓		✓		
see notes	2	2					3		3		1		1		3,4

- 1 Other pulse rates available.
- 2 Dual pulse rate output transmitters available.
- 3 Provides one contact per totalizer count.
- 4 Provides a 4 – 20 mA current signal proportional to the rate of flow.

Chart Recorder Flow Computers



	Model IN48	Model IN60	Model IN62
Digital	✓	✓	✓
Solid-state construction	✓	✓	✓
INPUT SIGNAL			
Current	✓	✓	
Pulse rate			✓
INDICATIONS			
Instantaneous flow rate indication	✓	✓	✓
Totalization of flow volume	✓	✓	✓
Record of flow rate	✓		
For use with these transmitters	TR15	TR15	TR01-1
	TR16	TR16	TR06-1
	FC101	FC101	



Flow range and accuracy selection chart

ACCURACY $\pm 2\%$ • FLOW RATE IN G.P.M.						
Meter size	Low-velocity construction*	Standard construction		High-velocity construction	Standard construction head loss @ max flow	
	MINIMUM – MAXIMUM	MIN – MAX	INTERMITTENT	MINIMUM – MAXIMUM	INCHES OF H ₂ O	PSI
2	35 – 120	40 – 160	225	n/a	49	1.77
3	40 – 250	45 – 250	350	n/a	25	.90
4	50 – 500	55 – 500	700	200 – 700	22	.79
6	90 – 1200	120 – 1200	1500	300 – 1500	18	.65
8	100 – 1500	150 – 1500	2000	400 – 2500	4	.15
10	125 – 2000	180 – 2000	3000	500 – 3500	3	.11
12	150 – 2800	200 – 3000	3500	800 – 5000	3	.11
14	250 – 3750	300 – 4000	4500	1000 – 6000	2.2	.08
16	350 – 4750	400 – 5000	6000	1200 – 7500	1.9	.07
18	450 – 5625**	700 – 6000	7500	1500 – 9000	1.9	.07
20	550 – 6875**	850 – 8000	9000	2000 – 12000	1.4	.05
24	800 – 10000**	1000 – 10000	13500	3000 – 15000	.83	.03
30	1200 – 15000**	1800 – 15000	21000	4000 – 25000	.5	.018
36	1500 – 20000**	2000 – 20000	30000	5000 – 35000	.5	.018
42	2000 – 28000**	3000 – 30000	40000	6000 – 50000	.5	.018
48	2500 – 35000**	5500 – 35000	50000	7000 – 60000	.5	.018
54	3200 – 45000**	6500 – 45000	55000	8000 – 65000	.4	.014
60	4000 – 60000**	7500 – 60000	80000	10000 – 90000	.4	.014
66	4750 – 75000**	8500 – 75000	95000	12000 – 105000	.4	.014
72	5500 – 90000**	9500 – 90000	115000	15000 – 125000	.3	.011
84	**	** – 125000	150000	**	.3	.011
96	**	** – 160000	200000	**	.3	.011
108	**	** – 200000	250000	**	.3	.011
120	**	** – 250000	300000	**	.3	.011

* Low velocity construction has the same low and maximum flow rates as AWWA C704-02. Low velocity meter sizes 2" through 48" are only available as main-line tube type. Sizes 54" through 120" are available on all other main-line meters.

** Consult factory for flow range or special construction

Standard construction will be supplied for all main-line meters unless special flow range, materials, or construction are required. Refer to individual data sheets for flow range of each model.

The meter must have a full flow of liquid for proper accuracy. Fully-opened gate valves, fittings, or other obstructions that tend to set up flow disturbances should be a minimum of five pipe diameters upstream and one pipe diameter downstream from the meter. Meters not equipped with straightening vanes must have a minimum of ten pipe diameters upstream and two pipe diameters downstream from the meter.

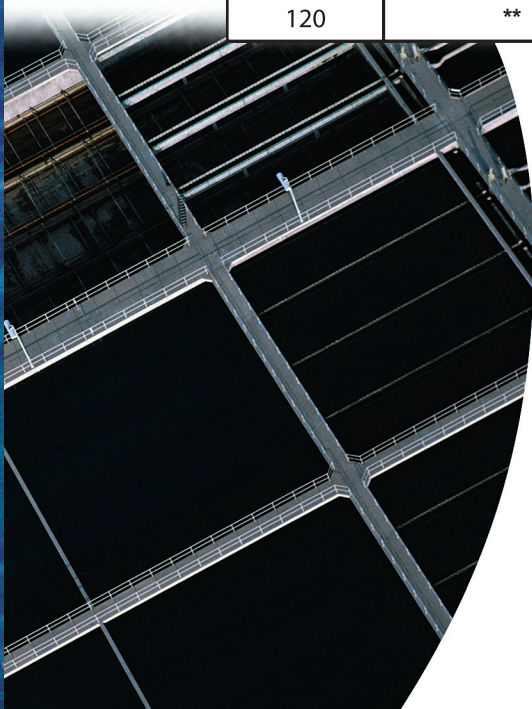

Meter testing

One of the world's largest volumetric test facilities owned by a meter manufacturer offers accuracy and calibration tests of flow meters $\frac{5}{8}$ " to 72" diameter, with flow rates up to 60,000 GPM. Expanded capabilities allow testing of up to 20 meters of the same size at one time. Every Water Specialties Propeller Meter is tested in its final form in the same pipe size and same tube style that the meter will be mounted in.



The testing is at minimum, intermediate, and maximum flow ranges of the meter and the amount of water used to conduct the test is left on the totalizer. If desired, the test may be witnessed by you, the customer, or your selected agent. A copy of the certified accuracy test record is furnished upon request. We can also test most types and brands of meters. Please consult our factory for any special testing you would like done.



The Water Specialties Propeller Meter is uniquely designed to meet the flow measurement needs of water and wastewater users.

Employed extensively in the water and wastewater industry, it has built a reputation for durability, reliability and high performance.

Our knowledgeable staff can assess your flow measurement application and help you find the best metering technology for your situation.

To find out more about our flow measurement products, or for a free flow evaluation, contact your nearest Water Specialties representative today or visit our website at www.mccrometer.com.

3255 West Stetson Avenue, Hemet, California 92545-7799, USA
TEL 951.652.6811 FAX 951.652.3078
www.mccrometer.com

 **McCROMETER**
The Flow Measurement Specialists