

EA403

FLOW COMPUTER

INSTALLATION & OPERATING INSTRUCTIONS



3255 West Stetson Avenue
Hemet, CA 92545-7799 USA

Tel: 951-652-6811 • Fax: 951-652-3078

www.mccrometer.com

email: info@mccrometer.com

CONTENTS

SAFETY INSTRUCTIONS	1
1. INTRODUCTION	
1.1 Unit Description	2
1.2 Specifications	3
2. INSTALLATION	
2.1 General Mounting Hints	9
2.2 Mounting Diagrams	9
3. APPLICATIONS	
3.1 Steam Mass	10
3.2 Steam Heat	11
3.3 Steam Net Heat	12
3.4 Steam Delta Heat	13
3.5 Corrected Gas Volume	14
3.6 Gas Mass	15
3.7 Gas Combustion Heat	16
3.8 Corrected Liquid Volume	17
3.9 Liquid Mass	18
3.10 Liquid Combustion Heat	19
3.11 Liquid Sensible Heat	20
3.12 Liquid Delta Heat	21
4. WIRING	
4.1 Terminal Designations	22
4.2 Typical Wiring Connections	23
4.2.1 Flow Input	23
4.2.2 Stacked DP Input	23
4.2.3 Pressure Input	23
4.2.4 Temperature Input	24
4.2.5 Temperature 2 Input	24
4.3 Wiring In Hazardous Areas	25
4.3.1 Flow Input	25
4.3.2 Pressure Input	25
4.3.3 Temperature Input	25
5. UNIT OPERATION	
5.1 Front Panel Operation Concept for Operate Mode	26
5.2 General Operation	27
5.3 Password Protection	27
5.4 Relay Operation	27
5.5 Pulse Output	27
5.6 Analog Outputs	27
5.7 Function Keys; Display Grouping	27
5.8 RS-232 Serial Port Operation	28
5.8.1 PC Communications	28
5.8.2 Operation of RS-232 Serial Port with Printers	28
5.9 Pause Computations Prompt	28
6. PROGRAMMING	
6.1 Front Panel Operation Concept for Program Mode	29
6.2 EZ Setup	30
6.3 Detailed Menu Descriptions	32
6.4 System Parameters	33
6.5 Display	38
6.6 System Units	40
6.7 Fluid Data	47
6.8 Flow Input	52
6.9 Other Input	64
6.10 Pulse Output	67
6.11 Current Output	70
6.12 Relays	72
6.13 Communication	76
6.14 Service & Analysis	85

CONTENTS

7. PRINCIPLE OF OPERATION

7.1 General	91
7.2 Square Law Flowmeter Considerations	91
7.3 Flow Equations	91
7.3.1 Flow Input Computation	91
7.3.2 Pressure Computation	92
7.3.3 Temperature Computation	92
7.3.4 Density/Viscosity Computation	92
7.3.5 Corrected Volume Flow Computation	93
7.3.6 Mass Flow Computation	94
7.3.7 Combustion Heat Flow Computation	94
7.3.8 Heat Flow Computation	95
7.3.9 Sensible Heat Flow Computation	95
7.3.10 Liquid Delta Heat Computation	95
7.3.11 Expansion Factor Computation for Square Law Flowmeters	95
7.3.12 Uncompensated Flow Computation	96
7.4 Computation of the D.P. Factor	97

8. RS-232 SERIAL PORT

8.1 RS-232 Serial Port Description	98
8.2 Instrument Setup by PC Over Serial Port	98
8.3 Operation of Serial Communication Port with Printers	98
8.4 EA403 RS-232 Port Pinout	98

9. FLOW COMPUTER SETUP SOFTWARE

9.1 System Requirements	99
9.2 Cable and Wiring Requirements	99
9.3 Installation for Windows™3.1 or 3.11	99
9.4 Using the Flow Computer Setup Software	99
9.5 File Tab	100
9.6 Setup Tab	100
9.7 View Tab	101
9.8 Misc. Tab	101

10. GLOSSARY OF TERMS

10 Glossary Of Terms	102
----------------------------	-----

11. Diagnosis and Troubleshooting

11.1 Response of EA403 on Error or Alarm	105
11.2 Diagnosis Flowchart and Troubleshooting	105
11.3 Error Messages	106

Appendix A

Fluid Properties Table	109
------------------------------	-----

Appendix B - Setup Menus

Setup Menus with Operator Code Access	110
Setup Menus with Supervisor Code Access	111

Warranty	112
Decoding Part Number	112



SAFETY INSTRUCTIONS

The following instructions must be observed.

- This instrument was designed and is checked in accordance with regulations in force EN 60950 (“Safety of information technology equipment, including electrical business equipment”).
A hazardous situation may occur if this instrument is not used for its intended purpose or is used incorrectly. Please note operating instructions provided in this manual.
- The instrument must be installed, operated and maintained by personnel who have been properly trained. Personnel must read and understand this manual prior to installation and operation of the instrument.
- The manufacturer assumes no liability for damage caused by incorrect use of the instrument or for modifications or changes made to the instrument.

Technical Improvements

- The manufacturer reserves the right to modify technical data without prior notice.

1. Introduction

1.1 Unit Description:

The EA403 Flow Computer satisfies the instrument requirements for a variety of flowmeter types in liquid, gas, steam and heat applications. Multiple flow equations are available in a single instrument with many advanced features.

The alphanumeric display offers measured parameters in easy to understand format. Manual access to measurements and display scrolling is supported.

The versatility of the Flow Computer permits a wide measure of applications within the instrument package. The various hardware inputs and outputs can be "soft" assigned to meet a variety of common application needs. The user "soft selects" the usage of each input/output while configuring the instrument.

The isolated analog output can be chosen to follow the volume flow, corrected volume flow, mass flow, heat flow, temperature, pressure, or density by means of a menu selection. Most hardware features are assignable by this method.

The user can assign the standard RS-232 Serial Port for data logging, or transaction printing, or for connection to a modem or two way pager for remote meter reading.

A PC Compatible software program is available which permits the user to rapidly redefine the instrument configuration.

Language translation features also permit the user to define his own messages, labels, and operator prompts. These features may be utilized at the OEM level to creatively customize the unit for an application or alternately to provide for foreign language translations. Both English and a second language reside within the unit.

NX-19

Calculations are available for Natural Gas applications where the user requires compensation for compressibility effects. Compensation for these compressibility effects are required at medium to high pressure and are a function of the gas specific gravity, % CO₂, % Nitrogen, as well as temperature and pressure. The compressibility algorithm used is that for NX-19.

Stacked differential pressure transmitters

This feature permits the use of a low range and high range DP transmitter on a single primary element to improve flow transducer and measurement accuracy.

EZ Setup

The unit has a special EZ setup feature where the user is guided through a minimum number of steps to rapidly configure the instrument for the intended use. The EZ setup prepares a series of questions based on flow equation, fluid, and flowmeter type desired in the application.

1.2 Specifications:

Environmental

Operating Temperature: 0 to +50 C
Storage Temperature: -40 to +85 C
Humidity : 0-95% Non-condensing
Materials: UL, CSA, VDE approved

Approvals: CE Approved Light Industrial, UL/CSA Pending

Display

Type: 2 lines of 20 characters
Type: Backlit LCD
Character Size: 0.3" nominal
User selectable label descriptors and units of measure

Keypad

Keypad Type: Membrane Keypad
Keypad Rating: Sealed to Nema 4
Number of keys: 16
Raised Key Embossing

Enclosure

Enclosure Type: Panel Mount
Size: See Chapter 2; Installation
Depth behind panel: 6.5" including mating connector
Type: DIN
Materials: Plastic, UL94V-0, Flame retardant
Bezel: Textured per matt finish
Equipment Labels: Model, safety, and user wiring

NX-19 Compressibility Calculations

Temperature	-40 to 240 F
Pressure	0 to 5000 psi
Specific Gravity	0.554 to 1.0
Mole % CO ₂	0 to 15%
Mole % Nitrogen	0 to 15%

Power Input

The factory equipped power options are internally fused. An internal line to line filter capacitor is provided for added transient suppression. MOV protection for surge transient is also supported

Universal AC Power Option:

85 to 276 Vrms, 50/60 Hz
Fuse: Time Delay Fuse, 250V, 500mA

Flow Inputs:
Flowmeter Types Supported:

Linear Flowmeters- Magnetic, Turbine, Positive Displacement, Vortex
 Square Law Flowmeters- Orifice, Venturi, Nozzle, Annubar, Pitot, V-Cone, Target, Wedge
 Other Flowmeters- Gilflo, Bypass Shunt

Analog Input:
Ranges

Voltage: 0-10 VDC, 0-5 VDC, 1-5 VDC

Current: 4-20 mA, 0-20 mA

Basic Measurement Resolution: 16 bit

Update Rate: 2 updates/sec minimum

Automatic Fault detection: Signal over/under-range, Current Loop Broken

Calibration: Operator assisted learn mode. Learns Zero and Full Scale of each range

Fault Protection:

Fast Transient: 1000 V Protection (capacitive clamp)

Reverse Polarity: No ill effects

Over-Voltage Limit: 50 VDC Over voltage protection

Over-Current Protection: Internally current limited protected to 24 VDC

Stacked DP transmitter 0-20 mA or 4-20 mA

Pulse Inputs:

Number of Flow Inputs: one

 Input Impedance: 10 k Ω nominal

Trigger Level: (menu selectable)

High Level Input

Logic On: 2 to 30 VDC

Logic Off: 0 to .9 VDC

Low Level Input (mag pickup)

Selectable sensitivity: 10 mV and 100 mV

Minimum Count Speed: 0.25 Hz

Maximum Count Speed: Selectable: 0 to 40 kHz

Overvoltage Protection: 50 VDC

Fast Transient: Protected to 1000 VDC (capacitive clamp)

Temperature, Pressure, Density Inputs

The compensation inputs usage are menu selectable for temperature, temperature 2, pressure, density, steam trap monitor or not used.

Calibration: Operator assisted learn mode

Operation: Ratiometric

Accuracy: 0.01% FS

Thermal Drift: Less than 100 ppm/C

Basic Measurement Resolution: 16 bit

Update Rate: 2 updates/sec minimum

Automatic Fault detection:

Signal Over-range/under-range

Current Loop Broken

RTD short

RTD open

Transient Protection: 1000 V (capacitive clamp)

Reverse Polarity: No ill effects

Over-Voltage Limit (Voltage Input): 50 VDC

Over-Current Limit (Internally limited to protect input to 24 VDC)

Available Input Ranges

(Temperature / Pressure / Density / Trap Monitor)

Current: 4-20 mA, 0-20 mA

Resistance: 100 Ohms DIN RTD

100 Ohm DIN RTD (DIN 43-760, BS 1904):

Three Wire Lead Compensation

Internal RTD linearization learns ice point resistance

1 mA Excitation current with reverse polarity protection

Temperature Resolution: 0.1°C

Stored Information (ROM)

Steam Tables (saturated & superheated), General Fluid Properties, Properties of Water, Properties of Air, Natural Gas

User Entered Stored Information (EEPROM / Nonvolatile RAM)

Transmitter Ranges, Signal Types

Fluid Properties

(specific gravity, expansion factor, specific heat, viscosity, isentropic exponent, combustion heating value, Z factor, Relative Humidity)

Units Selections (English/Metric)

RS-232 Communication

Uses: Printing, Setup, Modem, Two Way Pager, Datalogging

Baud Rates: 300, 600, 1200, 2400, 4800, 9600, 19200

Parity: None, Odd, Even

Device ID: 0 to 99

Protocol: Proprietary, Contact factory for more information

Chassis Connector Style: DB 9 Female connector

Power Output: 8V (150 mA max.) provided to Modem or Two Way Pager

Excitation Voltage

24 VDC @ 100 mA overcurrent protected

Relay Outputs

The relay outputs usage is menu assignable to (Individually for each relay) Hi/Lo Flow Rate Alarm, Hi/Lo Temperature Alarm, Hi/Lo Pressure Alarm, Pulse Output, Wet Steam or General purpose warning (security).

Number of relays: 2

Contact Style: Form C contacts

Contact Ratings: 240 V, 1 amp

Fast Transient Threshold: 2000 V

Analog Outputs

The analog output usage is menu assignable to correspond to the Heat Rate, Uncompensated Volume Rate, Corrected Volume Rate, Mass Rate, Temperature, Density, or Pressure.

Number of Outputs: 2

Type: Isolated Current Sourcing (shared common)

Isolated I/P/C: 500 V

Available Ranges: 0-20 mA, 4-20 mA (menu selectable)

Resolution: 16 bit

Accuracy: 0.05% FS at 20 Degrees C

Update Rate: 5 updates/sec

Temperature Drift: Less than 200 ppm/C

Maximum Load: 1000 ohms

Compliance Effect: Less than .05% Span

60 Hz rejection: 40 dB minimum

EMI: No effect at 10 V/M

Calibration: Operator assisted Learn Mode

Averaging: User entry of DSP Averaging constant to cause a smooth control action

Isolated Pulse output

The isolated pulse output is menu assignable to Uncompensated Volume Total, Compensated Volume Total, Heat Total or Mass Total.

Isolation I/O/P: 500 V

Pulse Output Form (menu selectable): Open Collector NPN or 24 VDC voltage pulse

Nominal On Voltage: 24 VDC

Maximum Sink Current: 25 mA

Maximum Source Current: 25 mA

Maximum Off Voltage: 30 VDC

Saturation Voltage: 0.4 VDC

Pulse Duration: User selectable

Pulse output buffer: 8 bit

Real Time Clock

The Flow Computer is equipped with either a super cap or a battery backed real time clock with display of time and date.

Format:

24 hour format for time

Day, Month, Year format for date

Measurement

The Flow Computer can be thought of as making a series of measurements of flow, temperature/density and pressure sensors and then performing calculations to arrive at a result(s) which is then updated periodically on the display. The analog outputs, the pulse output, and the alarm relays are also updated. The cycle then repeats itself.

Step 1: Update the measurements of input signals-

Raw Input Measurements are made at each input using equations based on input signal type selected. The system notes the "out of range" input signal as an alarm condition.

Step 2: Compute the Flowing Fluid Parameters-

The temperature, pressure, viscosity and density equations are computed as needed based on the flow equation and input usage selected by the user.

Step 3 : Compute the Volumetric Flow-

Volumetric flow is the term given to the flow in volume units. The value is computed based on the flowmeter input type selected and augmented by any performance enhancing linearization that has been specified by the user.

Step 4: Compute the Corrected Volume Flow at Reference Conditions-

In the case of a corrected liquid or gas volume flow calculation, the corrected volume flow is computed as required by the selected compensation equation.

Step 5 : Compute the Mass Flow-

All required information is now available to compute the mass flow rate as volume flow times density. A heat flow computation is also made if required.

Step 6: Check Flow Alarms-

The flow alarm functions have been assigned to one of the above flow rates during the setup of the instrument. A comparison is now made by comparing the current flow rates against the specified hi and low limits.

Step 7: Compute the Analog Output-

This designated flow rate value is now used to compute the analog output.

Step 8: Compute the Flow Totals by Summation-

A flow total increment is computed for each flow rate. This increment is computed by multiplying the respective flow rate by a time base scaler and then summing. The totalizer format also includes provisions for total rollover.

Step 9: Pulse Output Service-

The pulse output is next updated by scaling the total increment which has just been determined by the pulse output scaler and summing it to any residual pulse output amount.

Step 10: Update Display and Printer Output-

The instrument finally runs a task to update the various table entries associated with the front panel display and serial outputs.

Instrument Setup

The setup is password protected by means of a numeric lock out code established by the user. The help line and units of measure prompts assure easy entry of parameters.

An EZ Setup function is supported to rapidly configure the instrument for first time use. A software program is also available which runs on a PC using a RS-232 Serial for connection to the Flow Computer. Illustrative examples may be down loaded in this manner.

The standard setup menu has numerous subgrouping of parameters needed for flow calculations. There is a well conceived hierarchy to the setup parameter list. Selections made at the beginning of the setup automatically affect offerings further down in the lists, minimizing the number of questions asked of the user.

In the setup menu, the flow computer activates the correct setup variables based on the instrument configuration, the flow equation, and the hardware selections made for the compensation transmitter type, the flow transmitter type, and meter enhancements (linearization) options selected. All required setup parameters are enabled. All setup parameters not required are suppressed.

Also note that in the menu are parameter selections which have preassigned industry standard values. The unit will assume these values unless they are modified by the user.

Most of the process input variables have available a "default" or emergency value which must be entered. These are the values that the unit assumes when a malfunction is determined to have occurred on the corresponding input.

It is possible to enter in a nominal constant value for temperature or density, or pressure inputs by placing the desired nominal value into the default values and selecting "manual". This is also a convenience when performing bench top tests without simulators.

The system also provides a minimum implementation of an "audit trail" which tracks significant setup changes to the unit. This feature is increasingly being found of benefit to users or simply required by Weights and Measurement Officials in systems used in commerce, trade, or "custody transfer" applications.

Simulation and Self Checking:

This mode provides a number of specialized utilities required for factory calibration, instrument checkout on start-up, and periodic calibration documentation.

A service password is required to gain access to this specialized mode of operation. Normally quality, calibration, and maintenance personnel will find this mode of operation very useful.

Many of these tests may be used during start-up of a new system. Output signals may be exercised to verify the electrical interconnects before the entire system is put on line.

The following action items may be performed in the Diagnostic Mode:

- Print Calibration/Maintenance Report
- View Signal Input (Voltage, Current, Resistance, Frequency)
- Examine Audit Trail
- Perform a Self Test
- Perform a Service Test
- View Error History
- Perform Pulse Output Checkout / Simulation
- Perform Relay Output Checkout / Simulation
- Perform Analog Output Checkout / Simulation
- Calibrate Analog Inputs using the Learn Feature
- Calibrate Analog Output using the Learn Feature
- Schedule Next Maintenance Date

Note that a calibration of the analog input/output will advance the audit trail counters since it effects the accuracy of the system.

Operation of Steam Trap Monitor

In applications on Saturated Steam, the otherwise unused Compensation Input may be connected to a steam trap monitor that offers the following compatible output signal levels:

- 4mA = trap cold
- 12 mA = trap warm and open (blowing)
- 20 mA = trap warm and closed

In normal operation a steam trap is warm and periodically opens and closes in response to the accumulation of condensate. A cold trap is indication that it is not purging the condensate, a trap that is constantly blowing is an indication that it is stuck open. To avoid a false alarm, the EA403 permits the user to program a delay, or time period, which should be considered normal for the trap to be either cold, or open. An alarm will only be activated if the trap is detected as continuously being in the abnormal states for a time period greater than this TRAP ERROR DELAY time.

The user selects to use the Compensation Input for Trap Monitoring by selecting "4-20mA TRAP STATUS as the INPUT SIGNAL for OTHER INPUT1.

The user can program the ERROR DELAY time in HH:MM format into both the TRAP ERROR DELAY (cold trap error) menu and the TRAP BLOWING DELAY (trap stuck open) menu.

The EA403 will warn the operator of a TRAP ERROR when an abnormal condition is detected. The error can be acknowledged by pressing the ENTER key. However, the problem may reassert itself if there is a continued problem with the steam trap.

In addition, the event is noted in the ERROR LOG.

It is also possible for the user to program a trap malfunction as one of the conditions worthy of a CALL OUT of a problem by selecting this error in the ERROR MASK.

The Data-Logging option of the EA403 can also be used to log the performance of the trap by storing the % of time the trap has been cold, and/or blowing open during the datalog interval.

Datalogging Option

The Datalogging Option for the EA403 permits the user to automatically store sets of data items as a record on a periodic basis. A datalog record may be stored as the result of either a PRINT key depression, or an INTERVAL, or a TIME OF DAY request for a datalog.

The user defines the list of items to be included in each datalog by selecting these in the PRINT LIST menu located within the COMMUNICATIONS SUBMENU.

The user selects what will trigger a datalog record being stored in the PRINT INITIATE menu. The choices are PRINT KEY, INTERVAL, and TIME OF DAY.

The user can select the datalog store interval in a HH:MM format in the PRINT INTERVAL menu.

The user can also select the store time of day in a 24 hr HH:MM format in the PRINT TIME menu.

The user can also define whether he just wants the data stored into the datalogger, or if he wants the data both stored in the datalogger and sent out over the RS232 port in the DATALOG ONLY menu.

The user can define the format he wishes the data to be output in using the DATALOG FORMAT menu. Choices are PRINTER and DATABASE. PRINTER format will output the data records in a form suitable to dump to a printer. DATABASE format will output the values in a CSV, or Comma Separated Variable with Carriage return delimiting of each record.

A number of serial commands are also included to access and manipulate information stored with in the datalogger. Among these RS232 command capabilities are the following actions:

- Clear Data Logger
- Send all Data in Datalogger
- Send Only New Data since Datalogger was last Read
- Send Data for the date included in the request
- Send the column heading text for the CSV data fields
- Send the column units of measure text for the CSV data fields
- Store one new record into datalogger now
- Read Number of New Records in the datalogger
- Read number of records currently in the datalogger
- Read the maximum number of records capacity of the datalogger
- Move Pointer Back N records
- Dump Record at Pointer
- Dump records newer than pointer
- Dump data from N records back

The datalogger option is used in conjunction with the RS-232 port in remote metering applications.

The technical details associated with the serial commands are listed in Universal Serial Protocol Manual available upon request.

RS-232 Serial Port

The Flow Computer has a general purpose RS-232 Port which may be used for any one of the following purposes:

- Transaction Printing
- Data Logging
- Remote Metering by Modem
- Remote Metering by Two Way Pager
- Computer Communication Link
- Configuration by Computer
- Print System Setup
- Print Calibration/Malfunction History

Instrument Setup by PC's over Serial Port

A Diskette program is provided with the Flow Computer that enables the user to rapidly configure the Flow Computer using an Personnel Computer. Included on the diskette are common instrument applications which may be used as a starting point for your application. This permits the user to have an excellent starting point and helps speed the user through the instrument setup.

Operation of Serial Communication Port with Printers

The Flow Computer's RS-232 channel supports a number of operating modes. One of these modes is intended to support operation with a printer in metering applications requiring transaction printing, data logging and/or printing of calibration and maintenance reports.

For transaction printing, the user defines the items to be included in the printed document. The user can also select what initiates the transaction print generated as part of the setup of the instrument. The transaction document may be initiated via a front panel key depression.

In data logging, the user defines the items to be included in each data log as a print list. The user can also select when or how often he wishes a data log to be made. This is done during the setup of the instrument as either a time of day or as a time interval between logging.

The system setup and maintenance report list all the instrument setup parameters and usage for the current instrument configuration. In addition, the Audit trail information is presented as well as a status report listing any observed malfunctions which have not been corrected.

The user initiates the printing of this report at a designated point in the menu by pressing the print key on the front panel.

Operating Serial Communication Port with Modems

The EA403 offers a number of capabilities that facilitate its use with modems. The EA403's RS232 port can be connected to a modem in order to implement a remote metering system that uses either the phone companies standard phone lines or cellular telephone system. In addition to remote meter readings, the serial commands may also be used to examine and/or make setup changes to the unit, and to check for proper operation or investigate problems. Several hundred commands are supported. A compatible industrial modem accessory and interconnecting cabling is offered in the MPP2400N specifically designed for use with the EA403.

The EA403 and Modem can be used together to create systems with one or more of the following capabilities:

1. Poll the EA403 unit for information from a remote PC.
2. Call Out from the EA403 unit to a remote PC on a scheduled reading time and/or crisis basis
3. Some combination of the above two descriptions where the unit is polled by one PC and calls into to a different PC if a problem is detected.

In fact, up to five ST-2 units can share the same modem. Each EA403 must have a unique DEVICE ID. This multidropping of flow computers on a single modem is popular when there are several flow computers mounted near each other.

In most applications using modem communications, the EA403's RS232 USAGE is first set equal to MODEM. Each EA403 on a shared modem cable is given a unique serial device address or DEVICE ID. The BAUD RATE is commonly set to 2400, the PARITY set to NONE, and the HANSHAKING set to NONE to complete the basic setup. The remote PC's communication settings are chosen to match these.

The level of complexity of the Supetrol-2 to Modem connection can range from simple to more complex.

In a simple system a remote PC will call into the telephone number of the modem. The modem will answer the call, and establish a connection between the EA403 and the remote PC. An exchange of information can now occur. The EA403 will act as a slave and respond to commands and requests for information from the remote MASTER PC. The MASTER PC will end the exchange by handing up.

However, it is more common that the EA403 will be used to control the modem. In these applications the following communication menu settings would be used:

RS232 USAGE = MODEM
DEVICE ID, BAUD RATE, PARITY, and HANSHAKING are set
MODEM CONTROL = YES
DEVICE MASTER = YES (When multidropping several EA403's, only one unit will be the DEVICE MASTER)
MODEM AUTO ANSWER = YES (This instructs the unit to answer incoming calls)
HANG UP IF INACTIVE = YES (This instructs the unit to hang up the line if no activities occur within several minutes).

A more complex form of a remote metering system can be implemented where the EA403 will initiate a call to contact the remote PC at a scheduled time and/or in the event of a problem that has been detected. In these applications the EA403 has additional setup capabilities including:

The EA403 must have a unique identifier assigned to it (using the TAG NUMBER)
Call Out Telephone number must be entered in the CALL OUT NUMBER
The scheduled call out time for the daily reading must be entered in CALL OUT TIME
A decision must be made whether the unit will be used to call on error(s) in CALL ON ERROR
The particular error conditions to call out on must be defined in the ERROR MASK
The NUMBER OF REDIALS to be attempted if line is busy must be entered in that cell
HANG UP IF INACTIVE= YES will disconnect the call if remote computer does not respond.

Consult the Universal Serial Commands User Manual for details on the individual commands supported by the EA403. Contact the McCrometer Flow Applications Group for a discussion on the remote metering system capabilities you are considering.

NOTE: Some modems can be configured in advance to answer incoming calls, terminate phone connections if communications is lost. In such applications there may be no need for the EA403 to be functioning to "control" the modem. Setting the RS232 USAGE = COMPUTER will likely work.

Operating Serial Communication Port with Two Way Paging

The EA403 offers a number of capabilities that facilitate its use with two way paging systems. The EA403's RS232 port can be connected to a compatible two way pager transceiver in order to implement a wireless, two way paging, remote metering system. A compatible, industrial Two Way Pager Transceiver accessory is offered in the TWPW specifically designed for use with the EA403. A monthly service contract with a two way paging provider, for example Skytel, is required. The remote user or system sends or receives information from the EA403 using either a Two Way Pager, such as Motorola's Pagerwriter 2000 pager, or by email via the INTERNET.

In addition to obtaining remote meter readings, the serial commands may also be used to examine and/or make setup changes to the unit, and/or to check for proper operation or investigate problems. Several hundred commands are supported.

The EA403 and TWPW can be used together to create systems with one or more of the following capabilities:

1. Poll the EA403 unit for information from a remote PC over the Internet via email.
2. Call Out from the EA403 unit to a remote PC on a scheduled reading time and/or crisis basis by email and the internet
3. Some combination of the above two descriptions where the unit is polled by one PC and calls into to a different PC or pager if a problem is detected.

In fact, up to five ST-2 units can share the same Two Way Pager. Each EA403 must have a unique DEVICE ID. This multidropping of flow computers on a single Two Way Pager is popular when there are several flow computers mounted near each other.

The EA403's RS232 USAGE is first set equal to PAGER. Each EA403 on a shared PAGER is given a unique serial device address or DEVICE ID. The BAUD RATE is commonly set to 9600, the PARITY set to NONE, and the HANSHAKING set to NONE to complete the basic setup.

In a simple system, the EA403 will send an email to an address programmed into the unit. The recipient will receive a daily email report containing the information desired in the form of a readable report.

To setup the information to be sent in this example:

- Setup your desired PRINT LIST
- Setup what will initiate the storage of information in the PRINT INITIATE menu
- Setup any related parameters: PRINT INTERVAL or PRINT TIME
- Set DATALOG ONLY = YES if data records will be sent at a later time
= NO if data records will be sent immediately as well as being stored
- Set DATALOG FORMAT = PRINTER

To setup the communication channel, the following communication menu settings would be used:

- RS232 USAGE = PAGER
- Set the DEVICE ID,
- BAUD RATE= 9600,
- PARITY= NONE,
- HANDSHAKING=NONE
- DEVICE MASTER = YES (When multidropping several EA403, only one unit will be the DEVICE MASTER)
- CALL OUT NUMBER = <email name of receiver> or <PIN of receiving PAGER>
- CALL OUT TIME = time of a scheduled call out in HH:MM format (if used set a different call out time to each unit, several hours apart)
- NUMBER OF REDIALS = 3 (if there is poor coverage unit will try to up to 3 times)
- PAGER PIN NUMBER = <enter the Pager Pin Number given you by Skytel >
- DESTINATION TYPE= E-MAIL (or PAGER PIN if pager or mailbox)
- MAX BLOCK SIZE = 3 (This is number of blocks (1-4) of 128 bytes to be sent in each message. A smaller number of blocks increases the chance of successful communication transfers.

If you also wish the unit to CALL OUT in the event of a problem, the following menu settings would be used:

- CALL ON ERROR = YES
- ERROR MASK configured to suit the applications needs

Initial Installation and Startup

When a EA403 / TWP pair are first put on line, several service actions are required. These include:

1. Allow time for the EA403 to charge the batteries in the TWPNW (see note below)
2. Set up an account with Skytel and choose a suitable service plan for this application
3. Initializing the Pager using the EA403 INITIALIZE PAGER utility
4. Registering the pager with Skytel using the EA403 REGISTER PAGER utility
5. Observe a sample exchange of information between the EA403 and the remote user using the CLP PROGRESS

NOTE: It is important to wait 24 hours for the Two Way Pager Transceiver to charge its batteries prior to initial use. Otherwise erratic problems may occur during registration.

Special Utilities for steps 3, 4, and 5 are built into the EA403. These may be summarized as follows:

INITIALIZE PAGER = YES causes the EA403 to send commands to initialize the pager. The responses to the command can be either SUCCESS if all is well or FAILED if a problem is detected.

REGISTER PAGER = YES causes the EA403 to attempt to establish a connection with a local Skytel tower. A series of informative messages will appear as the EA403 attempts to register your PAGER PIN NUMBER with Skytel. Note that your service plan must be setup with Skytel before attempting to register the pager. The responses to the command can be either SUCCESS if all is well or FAILED if a problem is detected.

CLP PROGRESS is a diagnostic menu location that provides information on the information exchanges for test purposes (see CLP Progress Menu in chapter 6). Contact the applications group at KEP if problems are encountered in initial setup or use of two way paging applications.

A more complex form of a remote metering system can be implemented where the EA403 will initiate a call to a "mailbox" at Skytel. The Remote PC can access his mailbox and read and process the various messages over the internet as part of a customer billing system. Skytel offers a software developers kit for customers wishing to create custom solutions.

In each message, the EA403 provides a header containing information that can be used to determine such items as:

1. What is the TAG NO of the device that sent the information?
2. What is its SENSOR SN
3. What is its DEVICE ID?
4. What type of message follows?
 - a. Exception Report (Message Type-1)
 - b. Send one Data Set (Message Type 2)
 - c. Send all new Datalog Data Sets (Message type 3)
5. What is the time and data of the first data record?
6. What information is contained in the data fields of CSV that follow?
7. Message Delimiter (CRLF)
8. For commands returning data, the data now follows in a CSV format

Consult the Universal Serial Commands User Manual for details on the individual commands supported by the EA403.

Contact the KEP Flow Applications Group for a discussion on the remote metering system capabilities you are considering.

2. Installation

General Mounting Hints

2.1 General Mounting Hints:

The EA403 Flow Computer should be located in an area with a clean, dry atmosphere which is relatively free of shock and vibration. The unit is installed in a 5.43" (138mm) wide by 2.68" (68mm) high panel cutout. (see Mounting Dimensions) To mount the Flow Computer, proceed as follows:

Mounting Procedure

- a. Prepare the panel opening.
- b. Slide the unit through the panel cutout until it touches the panel.
- c. Install the screws (provided) in the mounting bracket and slip the bracket over the rear of the case until it snaps in place.
- d. Tighten the screws firmly to attach the bezel to the panel. 3 in. lb. of torque must be applied and the bezel must be parallel to the panel.

NEMA4X / IP65 Specifications

NOTE: To seal to NEMA4X / IP65 specifications, supplied bezel kit must be used and panel cannot flex more than .010".
When the optional bezel kit is used, the bezel adaptor must be sealed to the case using an RTV type sealer to maintain NEMA4X / IP65 rating.

2.2 Mounting Diagrams:

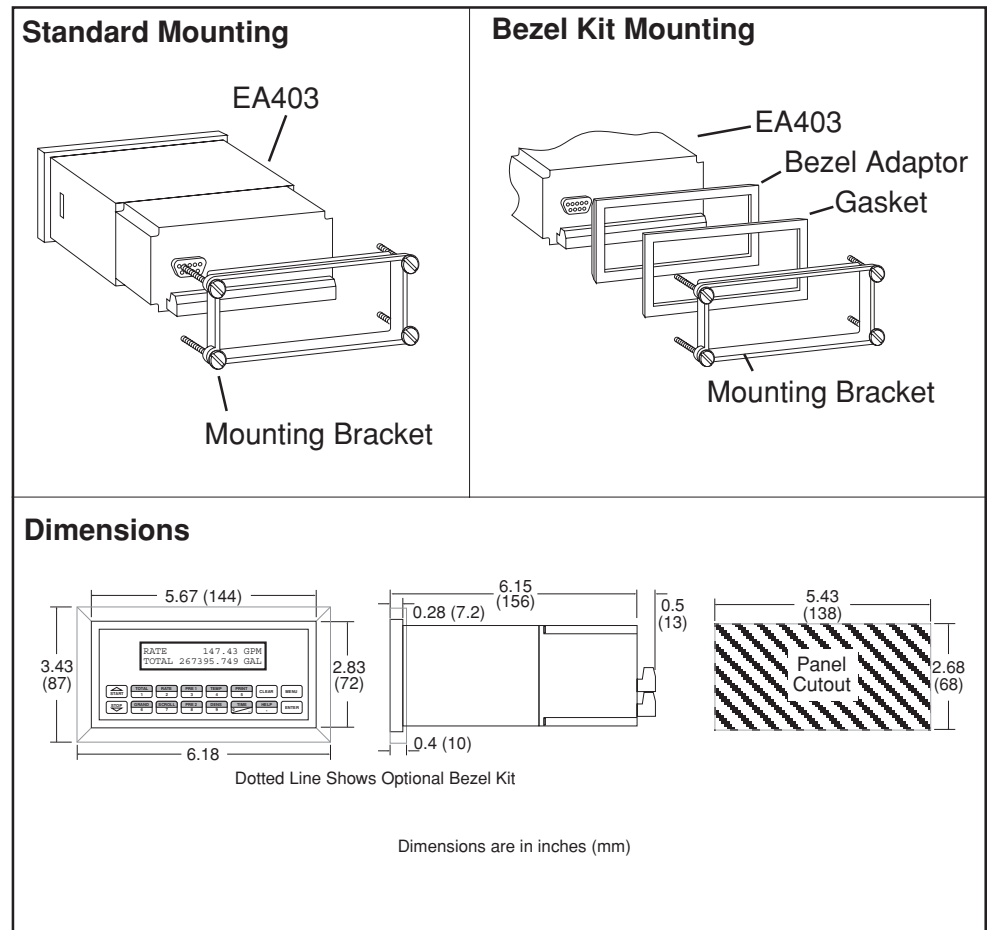

3. Applications

STEAM MASS

3.1 Steam Mass

Measurements:

A flowmeter measures the actual volume flow in a steam line. A temperature and/or pressure sensor is installed to measure temperature and/or pressure.

Calculations:

- Density and mass flow are calculated using the steam tables stored in the flow computer.
- With square law device measurement the actual volume is calculated from the differential pressure, taking into account temperature and pressure compensation.
- Saturated steam requires either a pressure or temperature measurement with the other variable calculated using the saturated steam curve.
- Optional steam trap monitoring using Compensation Input 1.

Input Variables:

- Superheated Steam:* Flow, temperature and pressure
- Saturated Steam:* Flow, temperature or pressure

Output Results:

- Display Results
Mass or Volume Flow Rate, Resettable Total, Non-Resettable Total, Temperature, Pressure, Density
- Analog Output
Mass or Volume Flow Rate, Temperature, Pressure Density,
- Pulse Output
Mass or Volume Total
- Relay Outputs
Mass or Volume Flow Rate , Total, Pressure, Temperature, Alarms,

Applications:

Monitoring mass flow and total of steam. Flow alarms are provided via relays and datalogging is available via analog (4-20mA) and serial outputs.

Steam Mass Illustration

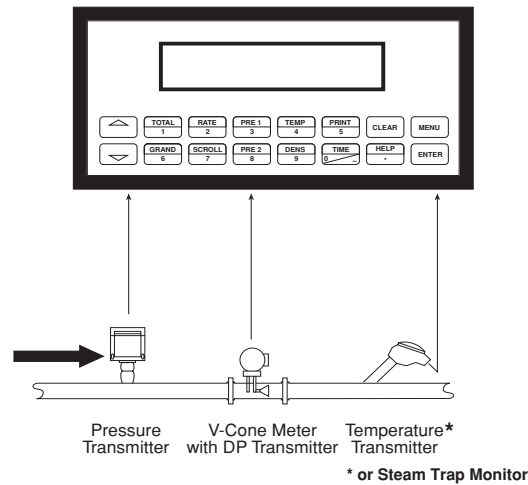

Calculations

Mass Flow

Mass Flow = volume flow • density (T, p)

STEAM HEAT

3.2 Steam Heat

Measurements:

A flowmeter measures the actual volume flow in a steam line. A temperature and/or pressure sensor is installed to measure temperature and/or pressure.

Calculations:

- Density, mass flow and heat flow are calculated using the steam tables stored in the flow computer. The heat is defined as the enthalpy of steam under actual conditions with reference to the enthalpy of water at T=0°C.
- With square law device measurement the actual volume is calculated from the differential pressure, taking into account temperature and pressure compensation.
- Saturated steam requires either a pressure or temperature measurement with the other variable calculated using the saturated steam curve.
- Optional steam trap monitoring using compensation input.

Input Variables:

Superheated Steam: Flow, temperature and pressure

Saturated Steam: Flow, temperature or pressure

Output Results:

- Display Results
Heat, Mass or Volume Flow Rate, Resettable Total, Non-Resettable Total, Temperature, Pressure, Density
- Analog Output
Heat, Mass or Volume Flow Rate, Temperature, Pressure, Density,
- Pulse Output
Heat, Mass or Volume Total
- Relay Outputs
Heat, Mass or Volume Flow Rate, Total, Pressure, Temperature Alarms,

Applications:

Monitoring heat flow and total heat of steam. Flow alarms are provided via relays and datalogging is available via analog (4-20mA) and serial outputs.

Steam Heat Illustration

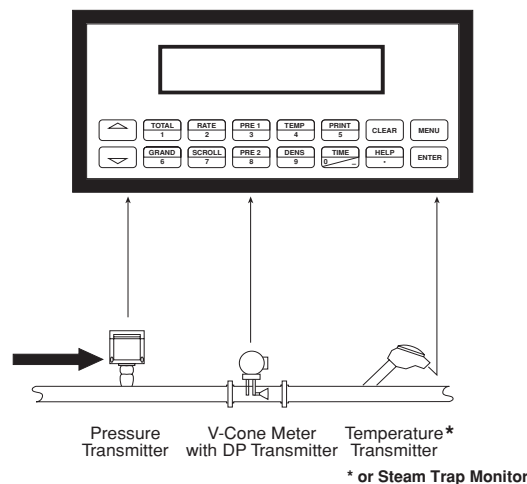

Calculations

Heat Flow

$$\text{Heat Flow} = \text{Volume flow} \cdot \text{density (T, p)} \cdot \text{Sp. Enthalpy of steam (T, p)}$$

STEAM NET HEAT

3.3 Steam Net Heat

Measurements:

A flowmeter measures the actual volume flow in a steam line. A temperature and a pressure sensor are installed to measure temperature and/or pressure. All measurement are made on the steam side of a heat exchanger.

Calculations:

- Density, mass flow and net heat flow are calculated using the steam tables stored in the flow computer. The net heat is defined as the difference between the heat of the steam and the heat of the condensate. For simplification it is assumed that the condensate (water) has a temperature which corresponds to the temperature of saturated steam at the pressure measured upstream of the heat exchanger.
- With square law device measurement the actual volume is calculated from the differential pressure, taking into account temperature and pressure compensation.
- Saturated steam requires either a pressure or temperature measurement with the other variable calculated using the saturated steam curve.
- Optional steam trap monitoring using compensation input.

Input Variables:

- Superheated Steam:* Flow, temperature and pressure
- Saturated Steam:* Flow, temperature or pressure

Output Results:

- Display Results
Heat, Mass or Volume Flow Rate, Resettable Total, Non-Resettable Total, Temperature, Pressure, Density, (
- Analog Output
Heat, Mass or Volume Flow Rate, Temperature, Pressure, Density,
- Pulse Output
Heat, Mass or Volume Total
- Relay Outputs
Heat, Mass or Volume Flow Rate , Total, Pressure, Temperature Alarms,

Applications:

Monitoring the thermal energy which can be extracted by a heat exchanger taking into account the thermal energy remaining in the returned condensate. For simplification it is assumed that the condensate (water) has a temperature which corresponds to the temperature of saturated steam at the pressure measured upstream of the heat exchanger.

Steam Net Heat Illustration

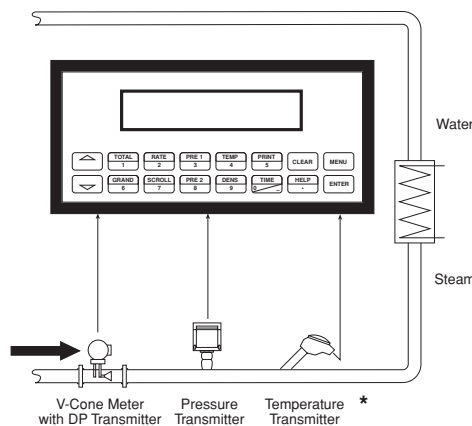

Calculations

Net Heat Flow

$$\text{Net Heat Flow} = \text{Volume flow} \cdot \text{density} (T, p) \cdot [E_D (T, p) - E_W (T_{S(p)})]$$

- E_D = Specific enthalpy of steam
- E_W = Specific enthalpy of water
- $T_{S(p)}^w$ = Calculated condensation temperature
(= saturated steam temperature for supply pressure)

STEAM DELTA HEAT 3.4 Steam Delta Heat

Measurements:

Measures actual volume flow and pressure of the saturated steam in the supply piping as well as the temperature of the condensate in the downstream piping of a heat exchanger.

Calculations:

- Calculates density, mass flow as well as the delta heat between the saturated steam (supply) and condensation (return) using physical characteristic tables of steam and water stored in the flow computer.
- With square law device measurement the actual volume is calculated from the differential pressure, taking into account temperature and pressure compensation.
- The saturated steam temperature in the supply line is calculated from the pressure measured there.

Input Variables:

Supply: Flow and pressure (saturated steam)

Return: Temperature (condensate)

Output Results:

- Display Results
Heat, Mass or Volume Flow Rate, Resettable Total, Non-Resettable Total, Temperature, Pressure, Density
- Analog Output
Heat, Mass or Volume Flow Rate, Temperature, Pressure, Density,
- Pulse Output
Heat, Mass or Volume Total
- Relay Outputs
Heat, Mass or Volume Flow Rate , Total, Pressure, Temperature Alarms,

Applications:

Calculate the saturated steam mass flow and the heat extracted by a heat exchanger taking into account the thermal energy remaining in the condensate.

Steam Delta Heat Illustration

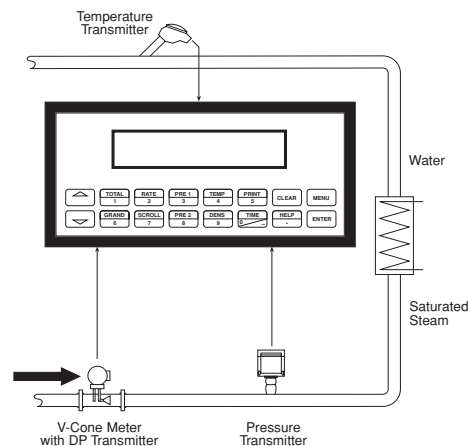

Calculations

Delta Heat Flow

$$\text{Net Heat Flow} = \text{Volume flow} \cdot \text{density} (\rho) \cdot [E_D (\rho) - E_w (T)]$$

E_D = Specific enthalpy of steam

E_w = Specific enthalpy of water

Note: Assumes a closed system.

CORRECTED GAS VOLUME

3.5 Corrected Gas Volume

Measurements:

A flowmeter measures the actual volume flow in a gas line. Temperature and pressure sensors are installed to correct for gas expansion effects.

Calculations:

- Corrected Volume is calculated using the flow, temperature and pressure inputs as well as the gas characteristics stored in the flow computer (see "FLUID DATA" submenu). Use the "OTHER INPUT" submenu to define reference temperature and reference pressure values for standard conditions.

Output Results:

- Display Results
Corrected Volume or Actual Volume Flow Rate, Resettable Total, Non-Resettable Total, Temperature, Pressure, Density
- Analog Output
Corrected Volume or Actual Volume Flow Rate, Temperature, Pressure, Density,
- Pulse Output
Corrected Volume or Actual Volume Total
- Relay Outputs
Corrected Volume or Actual Volume Flow Rate, Total, pressure, Temperature Alarms,

Applications:

Monitoring corrected volume flow and total of any gas. Flow alarms are provided via relays and datalogging is available via analog (4-20mA) and serial outputs.

Corrected Gas Volume Illustration

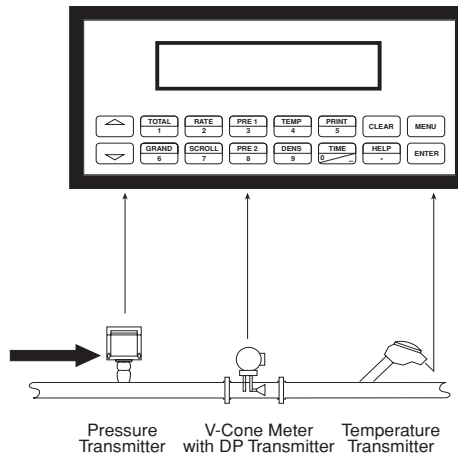

Calculations

Volume Flow

Pulse Input: Average K-Factor

$$\text{Volume Flow} = \frac{\text{input frequency} \cdot \text{time scale factor}}{\text{K-Factor}}$$

Analog Input: Linear

$$\text{Volume Flow} = \% \text{ input} \cdot \text{Full Scale Flow}$$

Corrected Volume Flow

$$\text{Corrected Volume Flow} = \text{Volume Flow} \cdot \frac{P}{P_{\text{ref}}} \cdot \frac{T_{\text{ref}}}{T} \cdot \frac{Z_{\text{ref}}}{Z}$$

GAS MASS
3.6 Gas Mass
Measurements:

A flowmeter measures the actual volume flow in a gas line. Temperature and pressure sensors are installed to measure temperature and pressure.

Calculations:

- Density and mass flow are calculated using gas characteristics stored in the flow computer.
- With square law device measurement the actual volume is calculated from the differential pressure, taking into account temperature and pressure compensation.

Output Results:

- Display Results
Mass or Volume Flow Rate, Resettable Total, Non-Resettable Total, Temperature, Pressure, Density
- Analog Output
Mass or Volume Flow Rate, Temperature, Pressure, Density,
- Pulse Output
Mass or Volume Total
- Relay Outputs
Mass or Volume Flow Rate, Total, Pressure, Temperature, Density Alarms,

Applications:

Monitoring mass flow and total of gas. Flow alarms are provided via relays and datalogging is available via analog (4-20mA) and serial outputs.

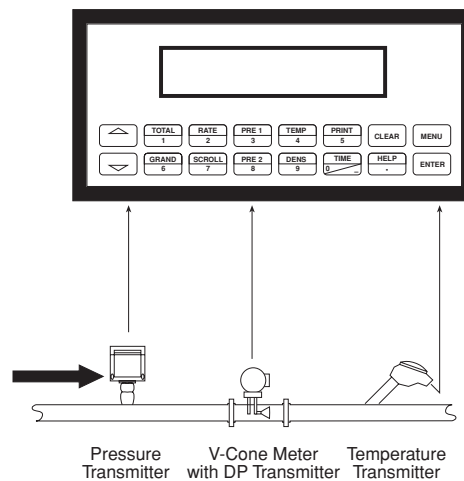
Gas Mass Illustration

Calculations
Mass Flow

$$\text{Mass Flow} = \text{Actual Volume Flow} \cdot \rho_{\text{ref}} \cdot \frac{P}{P_{\text{ref}}} \cdot \frac{T_{\text{ref}}}{T} \cdot \frac{Z_{\text{ref}}}{Z}$$

- ρ_{ref} = Reference density
- T_{ref} = Reference temperature
- P_{ref} = Reference pressure
- Z_{ref} = Reference Z-factor

GAS COMBUSTION HEAT

3.7 Gas Combustion Heat

Measurements:

A flowmeter measures the actual volume flow in a gas line. Temperature and pressure sensors are installed to measure temperature and pressure.

Calculations:

- Density, mass flow and combustion heat are calculated using gas characteristics stored in the flow computer.
- With square law device measurement the actual volume is calculated from the differential pressure, taking into account temperature and pressure compensation.

Output Results:

- Display Results
Heat, Mass or Volume Flow Rate, Resettable Total, Non-Resettable Total, Temperature, Pressure, Density
- Analog Output
Heat, Mass or Volume Flow Rate, Temperature, Pressure, Density
- Pulse Output
Heat, Mass or Volume Total
- Relay Outputs
Heat, Mass or Volume Flow Rate, Total, Pressure, Temperature Alarms,

Applications:

Calculate the energy released by combustion of gaseous fuels.

Gas Combustion Heat

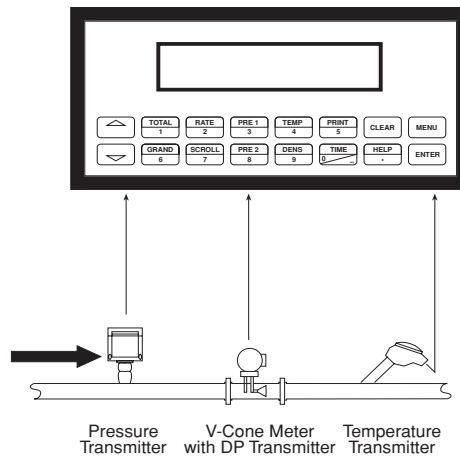

Calculations

Combustion Heat Flow

$$\text{Combustion Energy} = C \cdot \rho_{\text{ref}} \cdot Q \cdot \frac{P}{P_{\text{ref}}} \cdot \frac{T_{\text{ref}}}{T} \cdot \frac{Z_{\text{ref}}}{Z}$$

- C = Specific combustion heat
- ρ_{ref} = Reference density
- Q = Volume flow

Corrected Liquid Volume

3.8 Corrected Liquid Volume

Measurements:

A flowmeter measures the actual volume flow in a liquid line. A temperature sensor is installed to correct for liquid thermal expansion. A pressure sensor can be installed to monitor pressure. Pressure measurement does not affect the calculation.

Calculations:

- Corrected Volume is calculated using the flow and temperature inputs as well as the thermal expansion coefficient stored in the flow computer (see "FLUID DATA" submenu). Use the "OTHER INPUT" submenu to define reference temperature and density values for standard conditions.

Output Results:

- Display Results
Corrected Volume and Actual Volume Flow Rate, Resettable Total, Non-Resettable Total, Temperature, Pressure, Density
- Analog Output
Corrected Volume and Actual Volume Flow Rate, Temperature, Pressure, Density
- Pulse Output
Corrected Volume and Actual Volume Total
- Relay Outputs
Corrected Volume and Actual Volume Flow Rate, Total, Pressure, Temperature Alarms

Applications:

Monitoring corrected volume flow and total of any liquid. Flow alarms are provided via relays and datalogging is available via analog (4-20mA) and serial outputs.

Corrected Liquid Volume Illustration

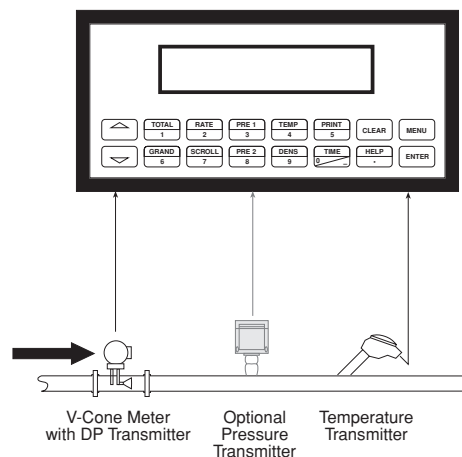

Calculations

Volume Flow

Pulse Input: Average K-Factor

$$\text{Volume Flow} = \frac{\text{input frequency} \cdot \text{time scale factor}}{\text{K-Factor}}$$

Analog Input: Linear

$$\text{Volume Flow} = \% \text{ input} \cdot \text{Full Scale Flow}$$

Corrected Volume Flow

$$\text{Corrected Volume Flow} = \text{vol. flow} \cdot (1 - \alpha \cdot (T_f - T_{ref}))^2$$

$$\alpha = \text{Thermal expansion coefficient} \cdot 10^{-6}$$

Liquid Mass

3.9 Liquid Mass

Measurements:

Actual volume flow is measured by the flow element (DP transmitter, Flowmeter). Temperature is measured by the temperature transmitter. A pressure transmitter can be used to monitor pressure. Pressure measurement does not affect the calculation. A density transmitter may be used in place of a temperature transmitter for direct density measurement.

Calculations:

- The density and mass flow are calculated using the reference density and the thermal expansion coefficient of the liquid (see "FLUID DATA" submenu)

Output Results:

- Display Results
Mass or Volume Flow Rate, Resettable Total, Non-Resettable Total, Temperature, Pressure, Density
- Analog Output
Mass or Volume Flow Rate, Temperature, Pressure, Density,
- Pulse Output
Mass or Volume Total
- Relay Outputs
Mass or Volume Flow Rate, Total, Temperature, Pressure, Density Alarms,

Applications:

Monitoring mass flow and total of any liquid. Flow alarms are provided via relays and datalogging is available via analog (4-20mA) and serial outputs.

Liquid Mass Illustration

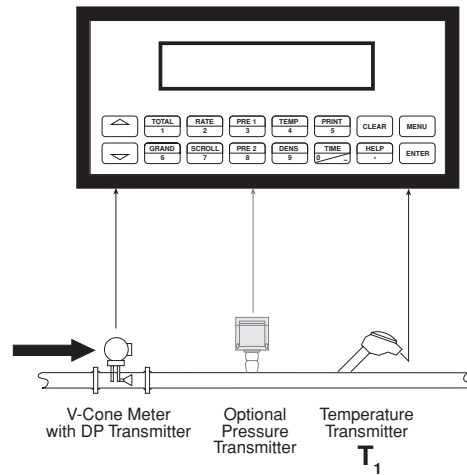

NOTE:

A density transmitter may be used for direct density measurement.

Calculations

Volume Flow

As calculated in section 3.8

Mass Flow

$$\text{Mass Flow} = \text{volume flow} \cdot (1 - \alpha \cdot (T_1 - T_{ref}))^2 \cdot \text{ref. density}$$

$$\alpha = \text{Thermal expansion coefficient} \cdot 10^{-6}$$

LIQUID COMBUSTION HEAT

3.10 Liquid Combustion Heat

Measurements:

Actual volume flow is measured by the flow element (DP transmitter, Flowmeter). Temperature is measured by the temperature transmitter. A pressure transmitter can be used to monitor pressure. Pressure measurement does not affect the calculation.

Calculations:

- The density, mass flow and combustion heat are calculated using the fluid characteristics stored in the flow computer. (see "FLUID DATA" submenu)

Output Results:

- Display Results
Combustion Heat, Mass or Volume Flow Rate, Resettable Total, Non-Resettable Total, Temperature, Pressure, Density
- Analog Output
Combustion Heat, Mass or Volume Flow Rate, Temperature, Pressure, Density,
- Pulse Output
Combustion Heat, Mass or Volume Total
- Relay Outputs
Combustion Heat, Mass or Volume Flow Rate, Total, Temperature, Pressure Alarms

Applications:

Calculate the energy released by combustion of liquid fuels

Liquid Combustion Heat Illustration

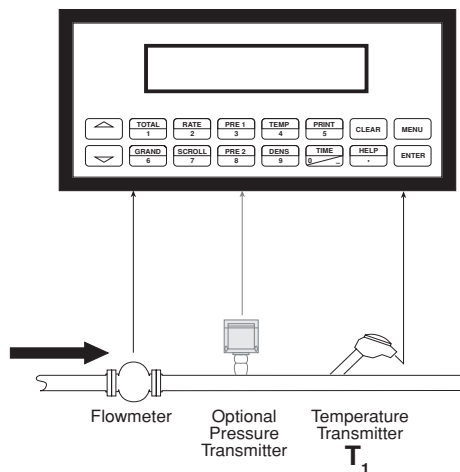

Calculations

Volume Flow

As calculated in section 3.8

Heat Flow

$$\text{Heat Flow} = C \cdot \text{volume flow} \cdot (1 - \alpha \cdot (T_1 - T_{\text{ref}}))^2 \cdot \text{ref. density}$$

- α = Thermal expansion coefficient $\cdot 10^{-6}$
 C = Specific combustion heat

LIQUID SENSIBLE HEAT

3.11 Liquid Sensible Heat

Measurements:

Actual volume flow is measured by the flow element (DP transmitter, Flowmeter). Temperature is measured by the temperature transmitter. A pressure transmitter can be used to monitor pressure. Pressure measurement does not affect the calculation.

Calculations:

- The density, mass flow and sensible heat are calculated using the fluid characteristics stored in the flow computer. (see "FLUID DATA" submenu)

Output Results:

- Display Results
Sensible Heat, Mass or Volume Flow Rate, Resettable Total, Non-Resettable Total, Temperature, Pressure, Density
- Analog Output
Sensible Heat, Mass or Volume Flow Rate, Temperature, Pressure, Density,
- Pulse Output
Sensible Heat, Mass or Volume Total
- Relay Outputs
Sensible Heat, Mass or Volume Flow Rate, Total, Temperature, Pressure Alarms,

Applications:

Calculate the energy stored in a condensate with respect to water at 32°F (0°C).

Liquid Sensible Heat Illustration

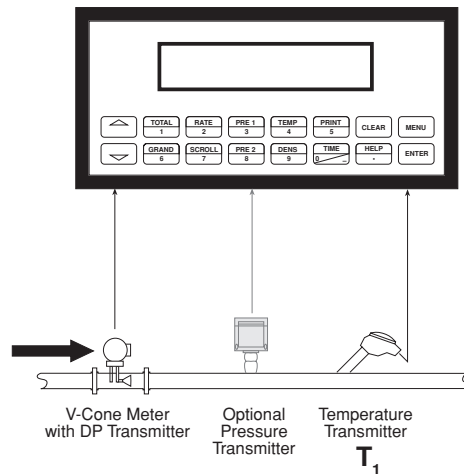

Calculations

Volume Flow

As calculated in section 3.8

Heat Flow

$$\text{Heat Flow} = C \cdot \text{volume flow} \cdot (1 - \alpha \cdot (T_1 - T_{ref}))^2 \cdot \text{ref. density} \cdot (T_1 - 32)$$

- α = Thermal expansion coefficient • 10⁻⁶
- C = Specific heat

LIQUID DELTA HEAT 3.12 Liquid Delta Heat

Measurements:

Actual volume flow is measured by the flow element (DP transmitter, Flowmeter). Temperature of the supply and return lines are measured by the temperature transmitters.

Calculations:

- The density, mass flow and delta heat are calculated using values of the heat carrying liquid stored in the flow computer. (see "FLUID DATA" submenu)

Output Results:

- Display Results
Heat, Mass or Volume Flow Rate, Resettable Total, Non-Resettable Total, Temperature1, Temperature2, Delta Temperature, Density
- Analog Output
Heat, Mass or Volume Flow Rate, Temperature1, Temperature2, Delta Temperature, Density
- Pulse Output
Heat, Mass or Volume Total
- Relay Outputs
Heat, Mass or Volume Flow Rate, Total, Temperature Alarms

Applications:

Calculate the energy which is extracted by a heat exchanger from heat carrying liquids.

Liquid Delta Heat Illustration

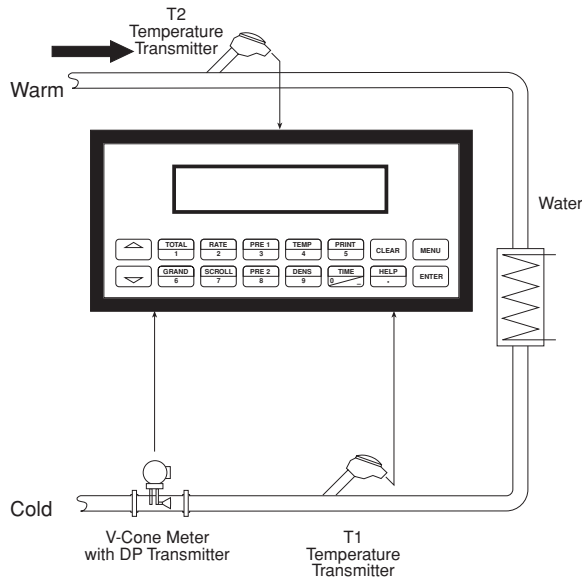

Calculations

Water

$$\text{Heat} = \text{Volume Flow} \cdot \rho(T_1) \cdot [h(T_2) - h(T_1)]$$

Other heat carrying liquids

$$\text{Heat} = C \cdot \text{volume flow} \cdot (1 - \alpha \cdot (T_1 - T_{ref}))^2 \cdot \rho_{ref} \cdot (T_2 - T_1)$$

WHERE: Delta T > Low Delta T Cutoff

- α = Thermal expansion coefficient • 10⁻⁶
- C = Mean specific heat
- $\rho(T_1)$ = Density of water at temperature T₁
- h(T₁) = Specific enthalpy of water at temperature T₁
- h(T₂) = Specific enthalpy of water at temperature T₂
- ρ_{ref} = Reference density
- T_{ref} = Reference temperature

4. WIRING

4.1 Terminal Designations

Two Relay Terminations

1	DC OUTPUT		
2	PULSE IN	Vin (+)*	FLOW
3	-----	lin (+)	IN
4	COMMON		
5	RTD EXCIT (+)		TEMPERATURE
6	RTD SENS (+)		IN
7	RTD SENS (-)	lin (+)**	
8	DC OUTPUT		
9	RTD EXCIT (+)		PRESSURE
10	RTD SENS (+)		(TEMP 2)
11	RTD SENS (-)	lin (+)	IN
12	PULSE OUTPUT (+)		
13	PULSE OUTPUT (-)		
14	ANALOG OUTPUT 1 (+)		
15	ANALOG OUTPUT 2 (+)		
16	ANALOG OUTPUT COMMON (-)		
17	NO		
18	COM RLY1		
19	NC		
20	NC		
21	COM RLY2		
22	NO		
23	AC LINE	DC (+)	POWER IN
24	AC LINE	DC (-)	

*In stacked DP mode, terminal 2 is used for Iin (+) DP Hi Range.
Terminal 3 is used for Iin (+) DP Lo Range.

**In trap monitor mode, terminal 7 is used for Iin (+) from trap monitor.

4.2 Typical Wiring Connections:

4.2.1 Flow Input

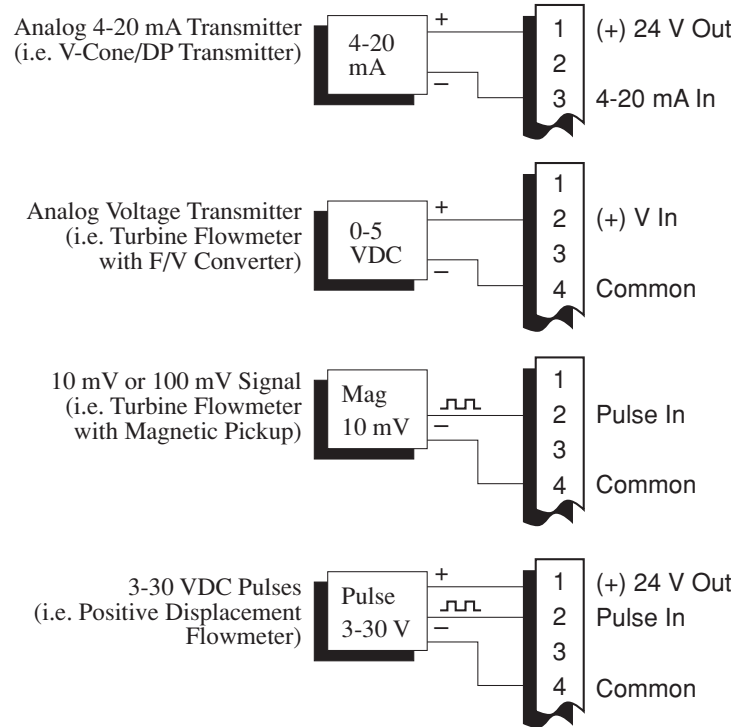

4.2.2 Stacked DP Input from V-Cone Flowmeter

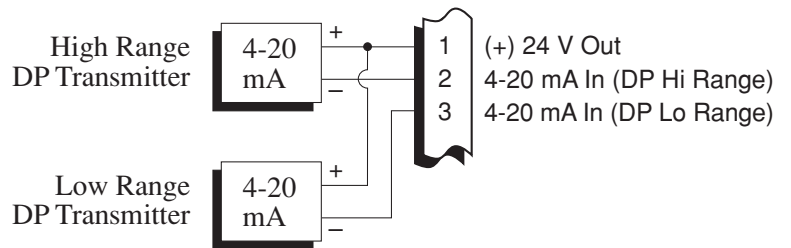

4.2.3 Pressure Input

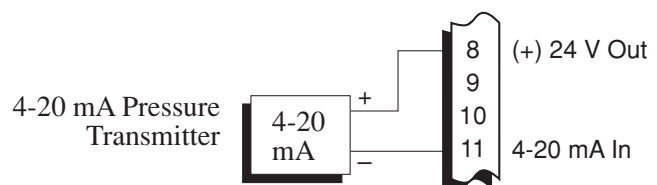

4.2.4 Temperature Input

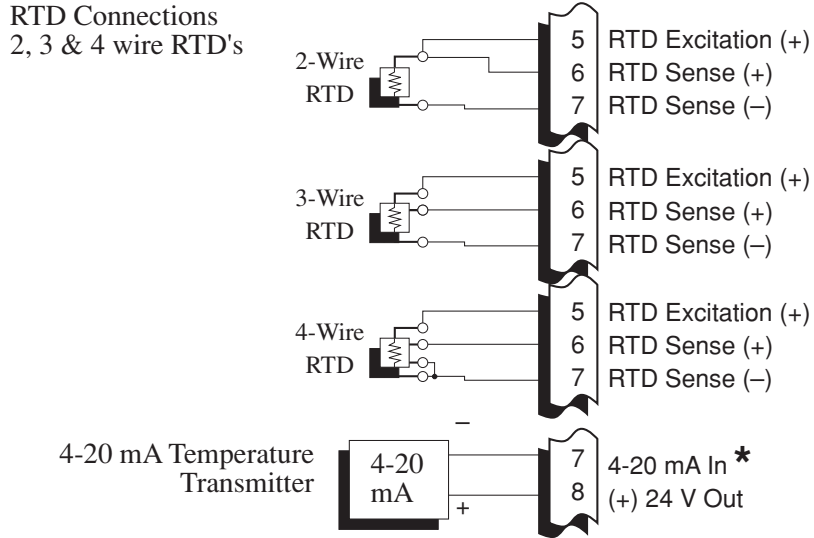

* Or optional steam trap monitoring input in some saturated steam applications.

4.2.5 Temperature 2 Input

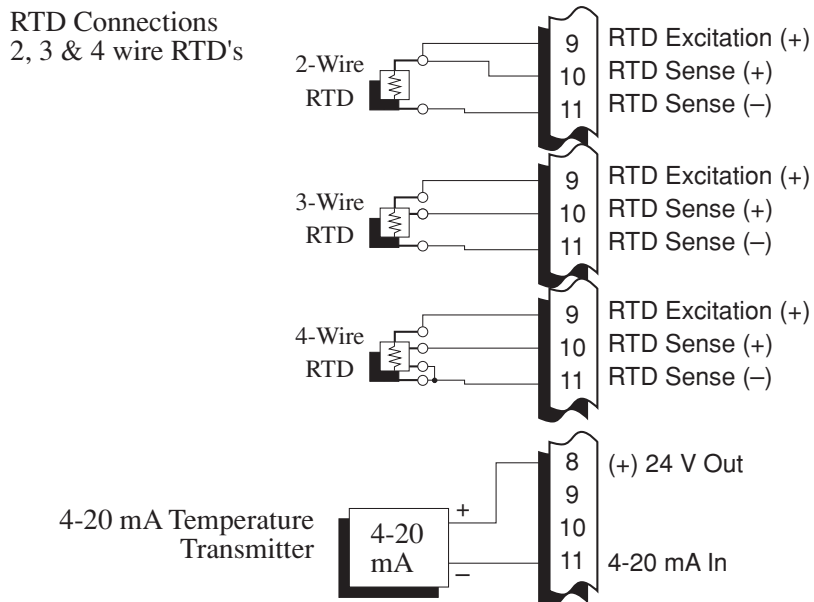

4.3 Wiring In Hazardous Areas

Examples using MTL787S+ Barrier (MTL4755ac for RTD)

4.3.1 Flow Input

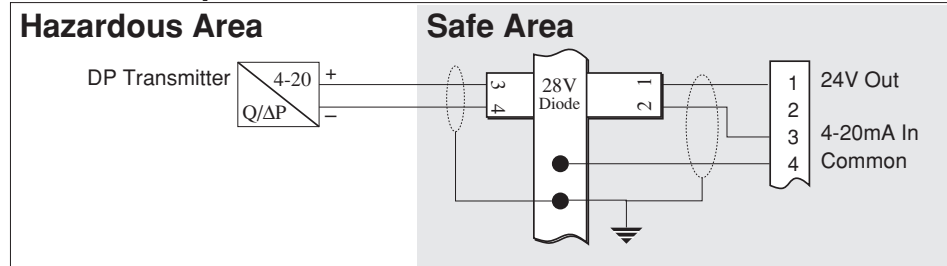

4.3.2 Pressure Input

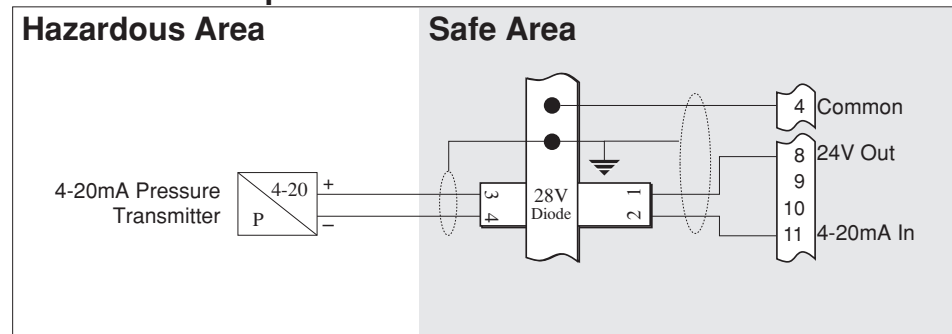

4.3.3 Temperature Input

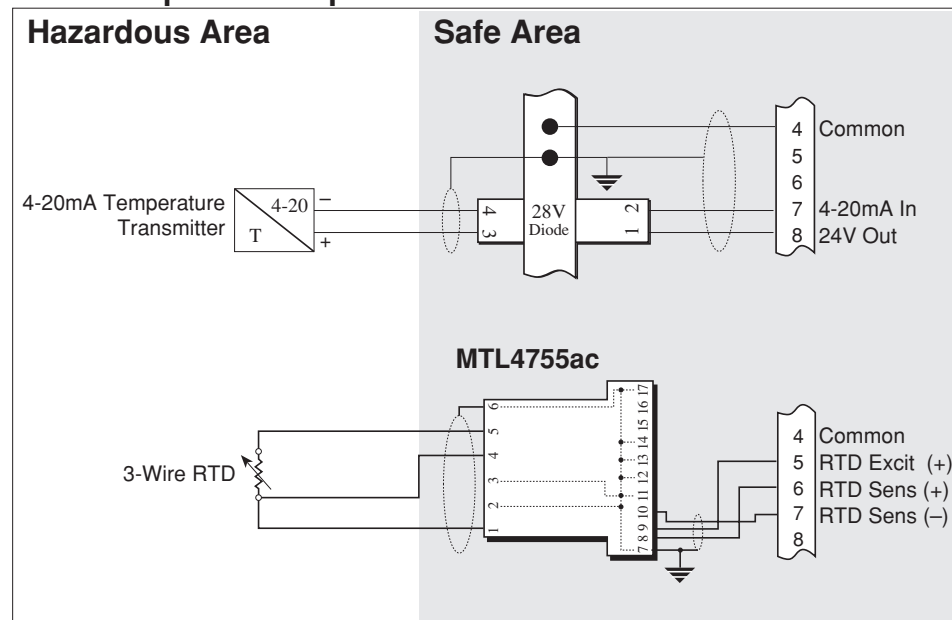

5. UNIT OPERATION

5.1 Front Panel Operation Concept for Operate Mode

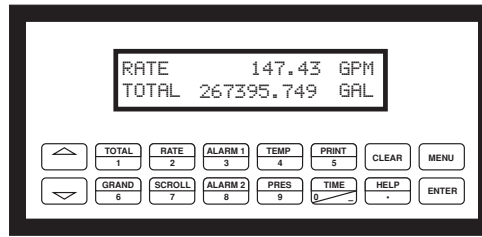

How To Use On-Line Help

HELP

On-line help is provided to assist the operator in using this product. The help is available during OPERATE and SETUP modes simply by pressing the HELP key. The HELP key is used to enter decimals when entering numeric values.

How To View Process Values

VIEWING PROCESS VALUES

In the OPERATE mode, several keys have a special, direct access feature, to display an item of interest (i.e. RATE, TOTAL, ALARM SETPOINT, etc.). Press the key to view your choice. Press the Δ ∇ keys to view other items in that group.

How To Clear The Totalizer

CLEARING TOTALIZER

To clear the totalizers, you must press the TOTAL Function Key to select the totalizer group. Press the Δ ∇ keys to select the desired totalizer. Once the desired totalizer is displayed, press the CLEAR key to reset the total. The operator will be prompted to verify this action and to enter a password if the unit is locked.

How To Clear The Grand Total

CLEARING GRAND TOTAL

To clear the grand totalizers, you must press the GRAND Function Key and use the Δ ∇ keys to select the desired grand total. Once the grand total is selected, press the CLEAR key to reset the grand total. The operator will be prompted to verify this action and to enter service password if the unit is locked.

How To Enter Alarm Setpoints

ALARM SETPOINT KEYS

ALARM 1 & ALARM 2 keys are used to view and/or change the alarm setpoints. To view the setpoints, simply press the desired Alarm setpoint key once. Rapidly press the alarm setpoint keys several times for direct editing of the alarm setpoints. The operator will be prompted to enter password if the unit is locked. Press CLEAR, "###", ENTER to enter value.

How To Activate The Scrolling Display List

SCROLL

Press the Scroll key to activate the scrolling display list. See section 6 to setup the display list.

How To Use The Print Key

PRINT

The PRINT key is used to print on demand when the communication port is set for printer. When the PRINT key is pressed, a user defined list of data (TOTAL, RATE, ALARM SETPOINT, etc.) is sent to the RS-232 port. A timed message of "PRINTING" will be displayed to acknowledge the print request.

How To Use The Menu Key

MENU KEY

The MENU key is used to view/enter the Instrument Setup and Service Mode. Press the MENU key to access the Setup and Service modes. (See section 6 for Setup mode). The MENU key is also used for a "Pop-Back" function. When the MENU key is pressed, the display will "Pop-Back" to the current submenu heading. Multiple MENU key depressions will return the unit to the Operate Mode.

How To Acknowledge Alarms

ACKNOWLEDGING ALARMS

Most alarm messages are self-clearing. Press the ENTER key to acknowledge and clear latching alarms.

NOTE: Some keys and functions are password protected. Enter the password to gain access. The passwords are factory set as follows:

Private = 1000, Service = 2000

General Operation
5.2 General Operation

This instrument is used primarily to monitor flowrate and accumulated total. The inputs can be software configured for a variety of flowmeter, temperature and pressure sensors. The standard output types include: Pulse, Relay, Analog and RS-232. The unit can display the flowrate, total and process variables.

Password Protection
5.3 Password Protection

After an Private and/or Service Code is entered in the "System Parameters" Submenu Group. (see section 6.3, Private Code and Service Code sub-menus), the unit will be locked. The unit will prompt the user for the password when trying to perform the following functions:

- Clear Totals
- Clear Grand Totals (service code required)
- Edit a Setup Menu Item
- Edit Alarm Setpoints (ALARM 1 & ALARM 2 Keys)

The Service Code should be reserved for service technicians. The Service Code will allow access to restricted areas of the Service and Test menus. Changes in these areas may result in lost calibration information.

Relay Operation
5.4 Relay Operation

Two relay alarm outputs are standard. The relays may also be used for pulse outputs. The relays can be assigned to trip according to various rate, total, temperature or pressure readings. The relays can be programmed for low/high alarms, latch or unlatch, or as relay pulse outputs.

ALARM SETPOINT 1 (RLY1) and ALARM SETPOINT 2 (RLY2) are easily accessible by pressing the ALARM 1 or ALARM 2 key on the front panel.







Pulse Output
5.5 Pulse Output

The isolated pulse output is menu assignable to any of the available totals. The pulse output duration and scaling can be set by the user. The pulse output is ideal for connecting to remote totalizers or other devices such as a PLC. See section 1.2 for electrical specifications.

Analog Outputs
5.6 Analog Outputs

The analog outputs are menu assignable to correspond to any of the process parameters. The outputs are menu selectable for 0-20 mA or 4-20 mA. The analog outputs are ideal for "trend" tracking using strip chart recorders or other devices.

Function Keys Display Grouping
5.7 Function Keys; Display Grouping

TOTAL	Press the  to view HEAT TOTAL, MASS TOTAL, CORRECTED VOLUME TOTAL, VOLUME TOTAL
GRAND TOTAL	Press the  to view GRAND HEAT, GRAND MASS, GRAND CORRECTED VOLUME, GRAND VOLUME
RATE	Press the  to view HEAT, MASS, CORRECTED VOLUME, VOLUME
TEMPERATURE	Press the  to view TEMPERATURE 1, TEMPERATURE 2, DELTA TEMPERATURE, DENSITY
PRESSURE	Press the  to view PRESSURE, DIFFERENTIAL PRESSURE, , Y ₁ , SPECIFIC ENTHALPY
TIME	Press the  to view TIME/DATE, ACCUMULATIVE POWER LOSS TIME, TIME OF LAST POWER OUTAGE, TIME POWER WAS LAST RESTORED

**RS-232 Serial Port
Operation****5.8 RS-232 Serial Port Operation**

The RS-232 serial port can be used for programming (using the Setup Disk) or for communicating to printers and computers in the Operating Mode (Run Mode). Enhanced uses include remote metering by modem or two way pager.

PC Communications**5.8.1 PC Communications:**

The Setup Disk also allows the user to query the unit for operating status such as Flow Rate, Flow Total, Temperature, Pressure, Alarm Setpoints, etc. In this mode of operation the RS232 port is assumed connected to a computer. The EA403 will act as a slave and answer requests from the PC. See the Universal Protocol Users Manual for a complete listing of the commands set supported. A DDE/OPC Server is also available for use in exchanging information with DDE Clients such as Spread Sheets, Database Programs, and HMI software.

**RS-232 Serial Port
Operation of RS-232 Serial
Port with Printers****5.8.2 Operation of RS-232 Serial Port with Printers:**Transaction Printing

For transaction printing, the user defines the items to be included in the printed document (see section 6.12 COMMUNICATION, Print List). The transaction document can be initiated by pressing the PRINT key.

Data Logging

The user can select when (time of day) or how often (print interval) the data log is to be made (see section 6.12 COMMUNICATION, Print Initiate). Information will be stored to the datalogger and optionally output to the RS-232 port.

System Setup and Maintenance Report

The system setup and maintenance report lists all of the instrument setup parameters and usage for the current instrument configuration. The audit trail information and a status report is also printed. This report is initiated in the Service and Analysis Group (see section 6.13 SERVICE & ANALYSIS, Print System Setup).

**Operation of RS-232 Serial
Port with Modems and
Pagers****5.8.3 Operation of RS-232 Serial Port with Modems and Pagers**Modem

In this mode of operation the RS232 port is assumed to be connected to KEP's MPP2400N or similar telephone modem. The EA403 is responsible for communicating to a remote computer through the modem to perform such actions as:

Answer incoming calls, process requests for information or action items or data log contents or change setup parameters, call out daily readings to designated phone number, call out to designated phone number in the case of a designated exception or malfunction in the unit, terminating telephone calls if a connection is lost.

Two Way Paging

In this mode of operation the RS232 port is assumed to be connected to KEP's TWP Two Way Pager Transceiver. The EA403 is responsible for communicating to the pager to perform such actions as:

Look for and process requests for information or change setup parameters, call out daily readings to designated pager/email address, call out to designated pager/email address in the case of a designated exception or malfunction in the unit.

**Pause Computations
Prompt****5.9 Pause Computations Prompt**

The user will be prompted with a "Pause Computations" message when making significant setup changes to the instrument. Pausing computations is necessary to make any significant changes. With computations paused, all outputs assume a safe state equal to that of an unpowered unit. Computations resume when exiting the setup menu.

6. PROGRAMMING

6.1 Front Panel Operation Concept for Program Mode

The EA403 is fully programmable through the front panel. The instrument setup menu structure is based on a number of topical submenu groups with one submenu group for each instrument function. Each submenu contains all of the individual settings associated with that function. During the instrument setup, setup topics are shown on the bottom line of the display while the detailed selection options are shown on the top line. A help menu is available for each menu item.

Please review the following key usage summary before attempting to setup the instrument.

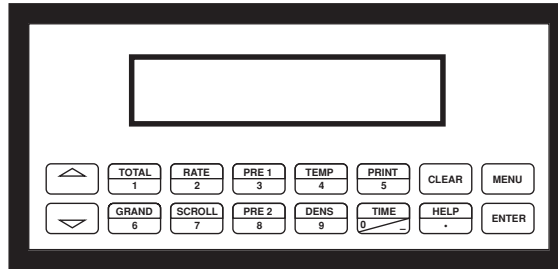

CAUTION: When the computations are paused the instrument outputs will go to a safe state which is the same as if the unit lost power. All calculations stop.

Key Usage Summary:



Menu Key

MENU KEY

Pressing the MENU key while in the "HOME" position will select the view setup parameters mode. Thereafter, the MENU key is used to "pop up" one menu level (i.e. return to the start of the submenu group). The unit will "pop up" one level for each time the **MENU key is pressed until finally returning to the "HOME" position of showing the "scroll" display list.**



Up & Down Arrow Keys

UP & DOWN ARROW KEYS

Use the UP and DOWN arrow keys to navigate through the submenu groups. The up and down arrow keys are also used to view the next/previous selection in a selection list within a submenu cell. When entering text characters, the UP and DOWN arrow keys are used to scroll through the available character sets for each individual character location. Press the ENTER key to accept the character and advance to the next character.



Help Key

HELP KEY

On-line help is available to assist the user during instrument setup. A quick help is provided at each setup step. Press the HELP key to display a help message for the current setup selection. This key is also used to enter decimals during numeric entry sequences.



Numeric Entry Keys

NUMERIC ENTRY KEYS

The keys labeled "0 - 9", "-", ".", CLEAR and ENTER are used to enter numerical values. A leading 0 will assume that you intend to enter a minus "-" sign. The standard numeric entry sequence is: CLEAR, "###", ENTER. Numeric entry values are bounded or clamped by minimum and maximum permitted values.



Clear Key

CLEAR KEY

The CLEAR key is used to clear numeric values to "0".



Enter Key

ENTER KEY

The ENTER key is used to accept the current value and advance to the next selection (Successfully terminate the current numeric entry sequence).

**6.2
EZ
SETUP**
(Continued)

EZ SETUP	
Fluid Type	<p>Select the type of fluid appropriate for your application.</p> <p>Selection:</p> <p> SATURATED STEAM, SUPERHEATED STEAM</p> <p>Display: SATURATED STEAM FLUID TYPE</p>
FLOWMETER TYPE	<p>Select the flowmeter type used in your application.</p> <p>Selection:</p> <p> LINEAR, SQR LAW, SQR LAW-LIN., LINEAR 16 PT, SQR LAW 16 PT, SQR LAW-LIN. 16 PT, LINEAR UVC, GILFLO, GILFLO 16 PT, BYPASS</p> <p>Display: LINEAR FLOWMETER TYPE</p>
INPUT SIGNAL	<p>Select the appropriate input signal.</p> <p>Selection:</p> <p> 4-20 mA, 0-20 mA, 0-5 Vdc, 1-5 Vdc, 0-10 Vdc, DIGITAL: 10 mV LEVEL, DIGITAL: 100 mV LEVEL, DIGITAL: 2.5 V LEVEL, 4-20mA STACKED, 0-20mA STACKED, 4-20mA LINEAR MANIFOLD, 0-20mA LINEAR MANIFOLD</p> <p>Display: DIGITAL 2.5 V LEVEL INPUT SIGNAL</p>
K-FACTOR	<p>Enter the K-Factor for the flowmeter.</p> <p>Input:</p> <p> Number with floating decimal point: 0.0001...999999</p> <p>Display: 123.67 P/ft³ K-FACTOR</p>
INPUT SIGNAL (PRESSURE)	<p>Select the appropriate pressure input signal.</p> <p>Selection:</p> <p> MANUAL PRESSURE, 4-20 PRESSURE (ABS.), 0-20 PRESSURE (ABS.), 4-20 PRESSURE (G), 0-20 PRESSURE (G)</p> <p>Display: 4-20 PRESSURE (ABS.) INPUT SIGNAL</p>

**6.2
EZ
SETUP**
(Continued)

EZ SETUP

FULL SCALE VALUE (PRESSURE)	<p>Enter the full scale value for the pressure input signal.</p> <p>Input:</p> <div style="display: flex; align-items: center;"> <p>Number with fixed decimal point: 000.000 ... 999.999</p> </div> <p>Display:</p> <div style="text-align: right; font-family: monospace;"> 580.000 psia FULL SCALE VALUE </div>
DEFAULT VALUE (PRESSURE)	<p>Enter the default value for the pressure input signal.</p> <p>Input:</p> <div style="display: flex; align-items: center;"> <p>Number with fixed decimal point: 000.000 ... 999.999</p> </div> <p>Display:</p> <div style="text-align: right; font-family: monospace;"> 14.696 psia DEFAULT VALUE </div> <p>NOTE: After the last entry has been saved, the display automatically returns to the HOME position. The “EZ Setup” routine is completed and the flow computations are resumed.</p>

**6.3
DETAILED
MENU
DESCRIPTION**

DETAILED MENU DESCRIPTION

The menu organization for the unit is depicted in Appendix B. The first depiction is that available with the operator password. The second is that available with supervisor password.

Please reference Appendix B while reviewing the detailed descriptions for each menu location in the following sections.

6.4
SYSTEM
PARAMETERS**SYSTEM PARAMETERS****EZ SETUP**

The EZ Setup routine is a quick and easy way to configure the most commonly used instrument functions.

Reference:

Refer to Section 6.2 for EZ Setup Programming.

Caution:

Entering the EZ Setup mode automatically sets many features to default values without informing the user. This may cause any previously programmed information to be lost or reset

Selection:

YES, NO

Display: EZ SETUP? NO
PAUSE COMPUTATIONS

Note:

The "Pause Computations" warning message informs the user that all computations are halted while programming EZ Setup.

ACCESS CODE

This is the menu location where the operator can unlock the unit by entering the correct password (operator or supervisor code), or lock the unit by entering the incorrect password.

Selection:

0 - 9999

Display: ACCESS CODE 0

**6.4
SYSTEM
PARAMETERS**
(Continued)

SYSTEM PARAMETERS

FLOW EQUATION

The Flow Equation sets the basic functionality of the unit. Choose the Flow Equation for your particular application.

Note:

Various setup data is only available depending on the flow equation selected. The flow equation also determines the assignment of the inputs.

Caution:

Select the flow equation as the first step. We recommend using the EZ Setup to select the proper flow equation. The user can then enter the submenu groups and make additional changes as desired.

Selection:



GAS COMBUSTION HEAT, GAS MASS, GAS CORRECTED VOLUME, STEAM DELTA HEAT, STEAM NET HEAT, STEAM HEAT, STEAM MASS, LIQUID DELTA HEAT, LIQUID SENSIBLE HEAT, LIQ. COMBUSTION HEAT, LIQUID MASS, LIQ. CORRECTED VOLUME.

Display:

STEAM MASS
FLOW EQUATIONS

ENTER DATE

Enter the date in this format: Day - Month - Year.

Note:

After prolonged breaks in the power supply (several days) or upon initial start-up of the unit, the date and time must be reset. This does not apply to units with the datalogger or language option.

Input:

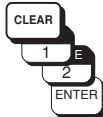

Flashing selections can be changed.
Store and Confirm entries with the ENTER key

Display:

08 FEB 1996
ENTER DATE

**DAYLIGHT SAVINGS
TIME**

The "Daylight Savings" mode allows the unit to automatically adjust the time according to daylight savings time change

Note:

Select "Yes" to enable the Daylight Savings Mode

Selection:



Yes, No

Display:

Yes
DAYLIGHT SAVINGS

6.4
SYSTEM
PARAMETERS
(Continued)

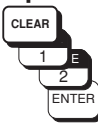
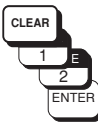
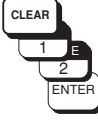
SYSTEM PARAMETERS	
<p>ENTER TIME</p>	<p>Enter the actual time in this format: Hours - Minutes</p> <p>Note: After prolonged breaks in the power supply (several days) or upon initial start-up of the unit, the date and time must be reset.</p> <p>Input:  Flashing selections can be changed. Store and Confirm entries with the ENTER key</p> <p>Display: 13:24 ENTER TIME</p>
<p>PRIVATE CODE</p> <p>Special Note: After returning to the run mode, program editing is automatically locked after 60 seconds as long as no keys are pressed. The program editing can also be disabled by entering a number other than the private code at the Access Code prompt.</p>	<p>A personal code may be defined. This code is used to enable program editing.</p> <p>Note:</p> <ul style="list-style-type: none"> • The private code is factory set to 1000 • Entering a private code of "0" will always enable program editing (Turns automatic lock off) <p>Input:  Maximum 4 digit number: 0...9999 Store and Confirm entries with the ENTER key</p> <p>Display: 1000 PRIVATE CODE</p>
<p>SERVICE CODE</p> <p>Note: The Service Code will allow access to the same information as the Private Code with the following additional functions:</p> <ul style="list-style-type: none"> • Change the Service Code • Change the Order Code • Change the Serial No. • Clear Grand Total • Clear Errors in Error Log • View & Perform calibration in Service & Analysis Menu • Restore Factory Calibration Information in Service & Analysis Menu • Set Next Calibration Date • Print Maint.Report • Perform Service Test 	<p>A personal service code may be defined. This code is used to enable program menus that are normally reserved for factory and service personnel. (i.e.: Service & Analysis Submenu Group)</p> <p>Note:</p> <ul style="list-style-type: none"> • The service code is factory set to 2000 • The service code submenu will only appear if the service code was entered for the "Access Code". <p>Input:  Maximum 4 digit number: 0...9999 Store and Confirm entries with the ENTER key</p> <p>Display: 2000 SERVICE CODE</p>

**6.4
SYSTEM
PARAMETERS**
(Continued)

SYSTEM PARAMETERS

ENGINEERING CODE

A personal engineering code may be defined. This code is used to enable program menus that are normally reserved for engineering personnel.
(i.e.: Service & Analysis Submenu Group)

Note:
The Engineering Code will allow access to the same information as the Private Code with the following additional functions:

- Change the Service Code
- Change the Order Code
- Change the Serial No.
- Clear Grand Total
- Clear Errors in Error Log
- View & Perform calibration in Service & Analysis Menu
- Restore Factory Calibration Information in Service & Analysis Menu
- Set Next Calibration Date
- Print Maint.Report
- Perform Service Test

Note:

- The engineering code is factory set to 3000
- The engineering code submenu will only appear if the engineering code was entered for the "Access Code".

Input:

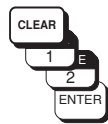

Maximum 4 digit number: 0...9999
Store and Confirm entries with the ENTER key

Display:

3000
SERVICE CODE

TAG NUMBER

A personalized tag can be entered for unit I.D. purposes.

Note:

- Maximum of 10 characters.
- Spaces are considered characters and must be confirmed by pressing the ENTER key.

Input:



Alphanumeric characters for each of 10 positions
1...9; A...Z; _, <, =, >, ?, etc.

Flashing selections can be changed.
Store and Confirm entries with the ENTER key.

Display:

FT101
TAG NUMBER

**6.4
SYSTEM
PARAMETERS**
(Continued)

SYSTEM PARAMETERS

ORDER CODE

The order code (part number) of the unit can be entered. This will help in identifying what options were ordered.

Note:

- The order number is set at the factory and should only be altered if options are added in the field by an authorized service technician.
- Maximum of 10 characters.

Input:

Alphanumeric characters for each of 10 positions
1...9; A...Z;

Flashing selections can be changed.
Store and Confirm entries with the ENTER key

Display: EA403V10P
 ORDER CODE

SERIAL NUMBER

The serial number of the unit is assigned at the factory.

Note:

Maximum of 10 characters.

Input:

Alphanumeric characters for each of 10 positions
1...9; A...Z;

Display: SN 12345
 SERIAL NUMBER

SERIAL-NO. SENS.

The serial number or tag number of the flowmeter can be entered.

Note:

Maximum of 10 characters.

Input:

Alphanumeric characters for each of 10 positions
1...9; A...Z;_, <, =, >, ?, etc.

Flashing selections can be changed.
Store and Confirm entries with the ENTER key.

Display: SN 12345
 SERIAL-NO. SENS.

6.5
DISPLAY

DISPLAY

SCROLL LIST

Select the variable that are to be displayed in the "HOME position" during normal operation. Each variable can be assigned to line 1 (L1), line 2 (L2) or NO (removed from scroll list).

Note:

- To initiate the scroll list press the SCROLL key. The list will be displayed in groups of two, each group is displayed for approximately 3 to 4 seconds.
- Any alarm messages will be displayed periodically, alternating throughout the scroll list.

Selection (with Prompt):



CHANGE? YES, NO

ADD TO LIST? L1, L2, NO

Variable Selection:

HEAT FLOW, MASS FLOW, VOLUME FLOW, STD. VOLUME FLOW, TEMP.1, TEMP.2, DELTA T, PRESSURE, DENSITY, SPEC. ENTHALPY, TIME, DATE, HEAT TOTAL, HEAT GRAND TOTAL, MASS TOTAL, MASS GRAND TOTAL, STD VOLUME TOTAL, STD.V. GRAND TOTAL, VOLUME TOTAL, VOL. GRAND TOTAL, PEAK DEMAND, DEMAND LAST HOUR, PEAK DEMAND TIME, PEAK DEMAND DATE

Note: Variable selection will vary depending on Flow Equation selected and options supplied.

Display: ADD TO LIST? L1
 HEAT FLOW?

**6.5
DISPLAY
(Continued)**
DISPLAY
**DISPLAY
DAMPING**

The "display damping" constant is used to stabilize fluctuating displays. The higher the constant, the less fluctuation will be displayed.

Note: Relay response time is affected by the value entered for display damping. The larger the display damping value, the slower the relay response time will be. This is intended to prevent false triggering of the relays. Enter a display damping factor of zero (0) for fastest response time.

Note:

- Factory setting: 1

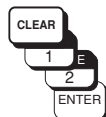
Input:

2 digits max; 0...99

Display: CONSTANT? 1
 DISPLAY DAMPING

MAX. DEC. POINT

Enter the number of decimal places for numerical values.

Note:

- The number of decimal places applies to all displayed variables and totalizers.
- The number of decimal places is automatically reduced if there is insufficient space available on the display for large numbers.
- The number of decimal places set here does not affect the functions set in the programming setup.

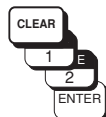
Selection:

0, 1, 2, 3 or 4 (decimal places)

Display: 3
 MAX. DEC. POINT

LANGUAGE

The language can be selected in which all text, parameters and operating messages are to be displayed.

Note:

- This function is supported by a special capability in the setup diskette.

Selection:

ENGLISH, OTHER

Display: ENGLISH
 LANGUAGE

**6.6
SYSTEM
UNITS****SYSTEM UNITS****TIME BASE**

Select "one" unit of time to be used as a reference for all measured or derived and time-dependant process variables and functions such as:

- flowrate (volume/time; mass/time)
- heat flow (amount of energy/time) etc.

Selection:

 /s (per second), /m (per minute),
/h (per hour), /d (per day)

Display:

/h
TIME BASE

HEAT FLOW UNIT

Select the unit for heat flow (amount of energy, combustion heat).

Note:

The unit selected here also applies to the following:

- Zero and full scale value for current.
- Relay setpoints

Selection:

kBtu/time base, kW, MJ/time base, kCal/time base, MW,
tons, GJ/h, Mcal/h, Gcal/h, Mbtu/h, Gbtu/h

Display:

kBtu/h
HEAT FLOW UNIT

HEAT TOTAL UNIT

Select the unit of heat for the particular totalizer.

Note:

The unit selected here also applies to the following:

- Pulse value for pulse output
- Relay setpoints



Selection:

kBtu, kWh, MJ, kCal, MWh, tonh,GJ, Mcal, Gcal, Mbtu, Gbtu

Display:

kBtu
HEAT FLOW UNIT

6.6
SYSTEM
UNITS
(Continued)

SYSTEM UNITS	
MASS FLOW UNIT	<p>Select the unit of mass flowrate (mass/time base).</p> <p>Note: The unit selected here also applies to the following:</p> <ul style="list-style-type: none">• Zero and full scale value for current• Relay setpoints <p>Selection:</p> <p> lbs/time base, kg/time base, g/time base, t/time base, tons(US)/time base, tons(long)/time base</p> <p>Display: lbs/h MASS FLOW UNIT</p> <hr/>
MASS TOTAL UNIT	<p>Select the unit of mass for the particular totalizer.</p> <p>Note: The unit selected here also applies to the following:</p> <ul style="list-style-type: none">• Pulse value for pulse output• Relay setpoints <p>Selection:</p> <p> lbs, kg, g, t, tons(US), tons(long), hlbs, Klbs, Mlbs</p> <p>Display: lbs MASS TOTAL UNIT</p>

**6.6
SYSTEM
UNITS**
(Continued)

SYSTEM UNITS

**COR.VOL.
FLOW UNIT**

Select the unit of corrected volumetric flowrate (corrected volume/time base).

Note:

The unit selected here also applies to the following:

- Zero and full scale value for current
- Relay setpoints

Corrected Volume = volume measured under operating conditions converted to volume under reference conditions.

Selection:

The available selections will change depending on the flow equation selected.



bbl/time base, gal/time base, l/time base, hl/time base, dm³/time base, ft³/time base, m³/time base, scf/time base, Nm³/time base, NI/time base, igal/time base, mcf/time base

All units listed above apply to corrected volume.

Display:

scf/h
COR.VOL. FLOW UNIT

**COR. VOLUME
TOT.UNIT**

Select the unit of volume for the particular totalizer.

Note:

The unit selected here also applies to the following:

- Pulse value for pulse output
- Relay setpoints

Corrected Volume = volume measured under operating conditions converted to volume under reference conditions.

Selection:

The available selections will change depending on the flow equation selected.



bbl, gal, l, hl, dm³, ft³, m³, scf, Nm³, NI, igal, mcf

All units listed above apply to corrected volume.

Display:

scf
COR.VOLUME TOT.UNIT

**6.6
SYSTEM
UNITS**
(Continued)

SYSTEM UNITS

VOLUME FLOW UNIT

Select the unit for volumetric flowrate.

Note:

The unit selected here also applies to the following:

- Zero and full scale value for current
- Relay setpoints

Selection:

The available selections will change depending on the flow equation selected.



bbl/time base, gal/time base, l/time base, hl/time base, dm³/time base, ft³/time base, m³/time base, acf/time base, igal/time base

All units listed above apply to the actual volume measured under operating conditions.

Display:

ft³/h
VOLUME FLOW UNIT

VOLUME TOTAL UNIT

Select the unit for uncorrected volume totalizer.

Note:

The unit selected here also applies to the following:

- Pulse value for pulse output
- Relay setpoints

Selection:

The available selections will change depending on the flow equation selected.



bbl, gal, l, hl, dm³, ft³, m³, acf, igal

All units listed above apply to the actual volume measured under operating conditions.

Display:

ft³
VOLUME TOTAL UNIT

**6.6
SYSTEM
UNITS**
(Continued)

SYSTEM UNITS

DEFINITION bbl

In certain countries the ratio of gallons (gal) per barrels (bbl) can vary according to the fluid used and the specific industry. Select one of the following definitions:

- US or imperial gallons
- Ratio gallons/barrel

Selection:

-  US: 31.0 gal/bbl for beer (brewing)
 US: 31.5 gal/bbl for liquids (normal cases)
 US: 42.0 gal/bbl for oil (petrochemicals)
 US: 55.0 gal/bbl for filling tanks
 imp: 36.0 gal/bbl for beer (brewing)
 imp: 42.0 gal/bbl for oil (petrochemicals)

Display: US: 31.0 gal/bbl
 DEFINITION bbl

TEMPERATURE UNIT

Select the unit for the fluid temperature.

Note:

The unit selected here also applies to the following:

- Zero and full scale value for current
- Relay setpoints
- Reference conditions
- Specific heat

Selection:

-  °C (Celsius), °F (Fahrenheit),
 °K (Kelvin), °R (Rankine)

Display: °F
 TEMPERATURE UNIT

6.6
SYSTEM
UNITS
(Continued)

SYSTEM UNITS

PRESSURE UNIT Select the unit for process pressure.

Note:
The unit selected here also applies to the following:

- Zero and full scale value for current
- Relay setpoints
- Reference conditions

Differential pressure is in mbar for Metric selections
Differential pressure is in "H₂O f or English selections

Selection:

 bara, kpaa, kc2a, psia, barg, psig, kpag, kc2g

Definitions:

bara	bar	
kpaa	kpa	Absolute pressure
kc2a	kg/cm ²	("a" for absolute)
psia	psi	
barg	bar	Gauge pressure compared to
kpag	kpa	atmospheric pressure
kc2g	kg/cm ²	("g" for gauge)
psig	psi	

Gauge pressure differs from absolute pressure by the atmospheric pressure, which can be set in the submenu group "OTHER INPUT".

Display: psia
 PRESSURE UNIT

DENSITY UNIT Select the unit for the density of the fluid.

Note:
The unit selected here also applies to the following:

- Zero and full scale value for current
- Relay setpoints

Selection:

 kg/m³, kg/dm³, #/gal, #/ft³
(# = lbs = 0.4536 kg)

Display: #/ft³
 DENSITY UNIT

6.6
SYSTEM
UNITS
(Continued)

SYSTEM UNITS	
SPEC. ENTHALPY UNIT	Select the unit for the combustion value (spec. enthalpy). Note: The unit selected here also applies to the following: <ul style="list-style-type: none">• Specific thermal capacity (kWh/kg → kWh/kg - °C) Selection:  btu/#, kWh/kg, MJ/kg, kCal/kg (# = lbs = 0.4536 kg) Display: Btu/# SPEC. ENTHALPY UNIT
LENGTH UNIT	Select the unit for measurements of length. Selection: in, mm Display: in LENGTH UNIT

6.7
FLUID DATA

FLUID DATA

FLUID TYPE

Select the fluid. There are three types:

1. Steam / Water

All information required for steam and water (such as saturated steam curve, density and thermal capacity) is permanently stored in the flow computer.

2. Fluid Displayed

Preset information for other fluids (such as air and natural gas) is stored in the flow computer and can directly adopted by the user.

If the preset values need to be changed to fit your specific process conditions, then proceed as follows:

Select the fluid (air or natural gas) and press the ENTER key (this sets all of the preset values).

Re-select the submenu group "FLUID TYPE", now choose "GENERIC" and ENTER. Now the preset values for the previously selected fluid can be altered.

3. Generic Fluid

Select the setting "GENERIC" for the Fluid type submenu. The characteristics of any fluid can now be defined by the user.

Selection:



GENERIC, WATER, SATURATED STEAM, SUPERHEATED STEAM, DRY AIR, HUMID AIR, HUMID GAS, NATURAL GAS, NATURAL GAS (NX-19), HYDROGEN, ARGON, METHANE, NITROGEN, CARBON DIOXIDE, PROPANE, OXYGEN, ETHANE, HELIUM

Display:

GENERIC
FLUID TYPE

REF. DENSITY

Select the density for a generic fluid at reference temperature and pressure (see "STP REFERENCE" in "OTHER INPUT" submenu group).

Input:

Number with floating decimal point: 0.0001...10000.0

Display:

.0760 #/ft3
REF. DENSITY

**6.7
FLUID DATA
(Continued)**

FLUID DATA

THERM. EXP. COEF.

Enter the thermal expansion coefficient for a generic liquid. The coefficient is required for the temperature compensation of volume with various flow equations (i.e. Liquid Mass or Corrected Liquid Volume).

Input:



Number with floating decimal point: 0.000...100000 (e-6)

The thermal expansion coefficient can be calculated as follows:

$$c = \frac{1 - \sqrt{\frac{\rho(T_1)}{\rho(T_0)}}}{T_1 - T_0} \cdot 10^6$$

- c Thermal expansion coefficient
- T₀, T₁ Temperatures at known points (see below)
- ρ (T₀, T₁) Density of the liquid at temperature T₀ or T₁

For optimum accuracy, choose the reference temperatures as follows:

- T₀: midrange temperature
- T₁: choose a second point at or near the maximum process temperature

10⁶ The value entered is internally multiplied by a factor of 10⁻⁶ (display: e-6/temp. unit) since the value to be entered is very small.

Display: 104.300 (e-6/oF)
THERM. EXP. COEF.

COMBUSTION HEAT

Enter the specific combustion heat for generic fuels.

Input:



Number with floating decimal point: 0.000...100000

Display: 1000.000 kBtu/lbs
COMBUSTION HEAT

SPECIFIC HEAT

Enter the specific heat capacity for generic fluids. This value is required for calculating the delta heat of liquids.



Input:



Number with floating decimal point: 0.000...10.000

Display: 10.000 kBtu/lbs-°F
SPECIFIC HEAT

**6.7
FLUID DATA
(Continued)**

FLUID DATA	
FLOW. Z-FACTOR	<p>Enter a Z-factor for the gas at operating conditions. The Z-factor indicates how different a "real" gas behaves from an "ideal gas" which exactly obeys the "general gas law" ($P \times V/T = \text{constant}$; $Z=1$). The further the real gas is from its condensation point, the closer the Z-factor approaches "1".</p> <p>Note:</p> <ul style="list-style-type: none"> • The Z-factor is used for all gas equations. • Enter the Z-factor for the average process conditions (pressure and temperature). <p>Input:</p>  Number with fixed decimal point: 0.1000...10.0000
	<p>Display: 1.000 FLOW. Z-FACTOR</p>
REF. Z-FACTOR	<p>Enter a Z-factor for the gas at reference conditions.</p> <p>Note:</p> <ul style="list-style-type: none"> • The Z-factor is used for all gas equations. • Define the standard conditions in the submenu "STP REFERENCE" (OTHER INPUT submenu group). <p>Input:</p> <p>Number with fixed decimal point: 0.1000...10.0000</p>
	<p>Display: 1.000 REF. Z-FACTOR</p>
ISENTROPIC EXP.	<p>Enter the isentropic exponent of the fluid. The isentropic exponent describes the behavior of the fluid when measuring the flow with a square law flowmeter. The isentropic exponent is a fluid property dependent on operating conditions.</p> <p>Note:</p> <p>Select one of the "SQR LAW" selections in "FLOWMETER TYPE" of submenu group "FLOW INPUT" to activate this function.</p> <p>Input:</p>  Number with fixed decimal point: 0.1000...10.0000
	<p>Display: 1.4000 ISENTROPIC EXP.</p>

6.7
FLUID DATA
 (Continued)

FLUID DATA

MOLE % NITROGEN

Enter the Mole % Nitrogen in the anticipated natural gas mixture. This information is needed by the NX-19 computation

Note:

Select "NATURAL GAS (NX-19)" in "FLUID TYPE" to activate this function.

Input:



Number with fixed decimal point: 0.00...15.00

Display:

0.00
 MOLE % NITROGEN

MOLE % CO₂

Enter the Mole % CO₂ in the anticipated natural gas mixture. This information is needed by the NX-19 computation

Note:

Select "NATURAL GAS (NX-19)" in "FLUID TYPE" to activate this function.

Input:



Number with fixed decimal point: 0.00...15.00

Display:

0.00
 MOLE % CO₂

VISCOSITY COEF. A

Enter the Viscosity coefficient A for the anticipated fluid. This information is needed by the viscosity computation for UVC and for Reynolds Number calculations.

Note:

Select "SQUARE LAW 16PT" or "LINEAR UVC" in "FLOWMETER TYPE" to activate this function.

Input:



Number with fixed decimal point: 0.000000...1000000

Display:

0.000444
 VISCOSITY COEF. A

**6.7
FLUID DATA
(Continued)**

FLUID DATA

VISCOSITY COEF. B

Enter the Viscosity coefficient B for the anticipated fluid. This information is needed by the viscosity computation for UVC and for Reynolds Number calculations.

Note:

Select "SQUARE LAW 16PT" or "LINEAR UVC" in "FLOWMETER TYPE" to activate this function.

Input:



Number with fixed decimal point: 0.000000...1000000

Display:

0.3850
VISCOSITY COEF. B

**Computation
of Viscosity
Coef. A and B**

Computation of Viscosity Coef. A and B

The flow computer solves an equation which computes the viscosity as a function of temperature. Two parameters must be entered for this calculation to be performed. These are the setup parameters Viscosity Coef. A and Viscosity Coef. B. A table listing these values for common fluids is available from KEP.

Alternately, if your intended fluid is not listed, the Viscosity Coef. A and B can be derived from two known temperature/viscosity pairs. Begin by obtaining this information for you intended fluid. Convert these known points to units of Degrees F and centipoise (cP)

The information is now in a suitable form to compute the Viscosity Coef. A and Viscosity Coef. B using the following equation based on the fluid state.

For a liquid, A and B are computed as follows:

$$B = \frac{(T1 + 459.67) \cdot (T2 + 459.67) \cdot \ln [cP1/cP2]}{(T2 + 459.67) - (T1 + 459.67)}$$

$$A = \frac{cP1}{\exp [B / (T1 + 459.67)]}$$

For a gas, A and B are computed as follows:

$$B = \frac{\ln [cP2 / cP1]}{\ln [(T2 + 459.67) / (T1 + 459.67)]}$$

$$A = \frac{cP1}{(T1 + 459.67)^B}$$

NOTE: $cS = \frac{cP}{\text{Density (in kg/l)}}$

% RELATIVE HUMIDITY

Enter the % Relative Humidity in the anticipated gas mixture. This information is needed to more accurately compute the density of a Humid gas.

nput:



Number with fixed decimal point: 0.000000...100.0000

Display:

0.3850
% RELATIVE HUMIDITY

6.8
FLOW INPUT

FLOW INPUT

FLOWMETER TYPE

Select the flowmeter type. The flow equation (see SYSTEM PARAMETERS) and the flowmeter selected here determine the basic operation of the flow computer.

.



Selection: 

LINEAR	Volumetric flowmeter with linear pulse or analog output.
SQR LAW	Differential pressure transmitter without square root extraction, with analog output.
SQR LAW-LIN.	Differential pressure transmitter with square root extraction and analog output.
LINEAR 16 PT*	Volumetric flowmeter with nonlinear pulse or analog output; with 16 point linearization table.
SQR LAW 16 PT*	Differential pressure transmitter without square root extraction, with analog output and 16 point linearization table.
SQR LAW-LIN. 16 PT*	Differential pressure transmitter with square root extraction, analog output and 16 point linearization table.
LINEAR UVC	Volumetric Turbine flowmeter with UVC calibration curve documentation and pulse output.
LINEAR MANIFOLD	Linear manifold consists of 2 linear flowmeters used in conjunction with an external bypass/diverter valve. It may be used with turbine, PD, Mag, Vortex flowmeters equipped with analog outputs to extend the allowable turndown range.
GILFLO	Gilflo flowmeters are special purpose differential pressure type flowmeters with an analog output where the differential pressure is linear with flow.
GILFLO 16PT	Gilflo 16 PT flowmeters are special purpose differential pressure type flowmeters with an analog output where the differential pressure is approximately linear with flow, but can be further enhanced by a 16 point linearization table.
BYPASS	BYPASS is a selection for use with Bypass(Shuntflow) flowmeters equipped with a pulse output.

* A linearization table must be entered by user.
(see "LINEARIZATION" submenu).

Display: LINEAR
 FLOWMETER TYPE

6.8
FLOW INPUT
(Continued)

FLOW INPUT	
SQUARE LAW FLOWMETER	<p>Select the type of square law flowmeter to be used with the instrument.</p> <p>Note: This selection will only appear if one of the Square Law selections were made in "FLOWMETER TYPE".</p> <p>Selection:  ORIFICE, V-CONE, ANNUBAR, PITOT, VENTURI, FLOW NOZZLE, BASIC SQRLAW/TARGET, WEDGE</p> <p>Display: ORIFICE SQUARE LAW FLOWMETER</p>
INPUT SIGNAL	<p>Select the type of measuring signal produced by the flowmeter.</p> <p>Selection:  DIGITAL, 10 mV LEVEL Voltage pulses, 10mV trigger threshold. DIGITAL, 100 mV LEVEL Voltage pulses, 100mV trigger threshold. DIGITAL, 2.5 V LEVEL Voltage pulses, 2.5V trigger threshold.</p> <p>4-20 mA 4-20 mA current signal 0-20 mA 0-20 mA current signal 4-20 mA STACKED 4-20 mA current signal 0-20 mA STACKED 0-20 mA current signal</p> <p>0-5 V 0-5 V voltage signal 1-5 V 1-5 V voltage signal 0-10 V 0-10 V voltage signal</p> <p>Display: 4-20 mA INPUT SIGNAL</p>
LOW SCALE	<p>Set the low scale value for the analog input signal. The value entered here must be identical to the value set for the flowmeter.</p> <p>Note:</p> <ul style="list-style-type: none"> • For flowmeters with analog/linear output, the flow computer uses the selected system units for volumetric flowrate. • The units for differential pressure flowmeters are dependent on the system units selected for pressure: <ul style="list-style-type: none"> - Imperial units [inches H2O] - Metric units: [mbar] <p>Input: Number with floating decimal point: 0.000...999999</p> <p>Display: .000 ft³/h LOW SCALE VALUE</p>

**6.8
FLOW INPUT**
(Continued)

FLOW INPUT

FULL SCALE

Set the full scale value for the analog input signal.
The value entered here must be identical to the value set for the flowmeter.

Note:

- For flowmeters with analog/linear output, Target, generic square law and Gilflo flowmeters, the flow computer uses the selected system units for volumetric flowrate.
- The units for differential pressure flowmeters are dependent on the system units selected for pressure:
 - Imperial units [inches H2O]
 - Metric units: [mbar]

Input:



Number with floating decimal point: 0.000...999999

Display:

10000.00 ft³/h
FULL SCALE VALUE

LOW SCALE-HI RANGE

Set the low scale value for the high range transmitter analog input signal.
The value entered here must be identical to the value set for the flowmeter.

Note:

- The units for differential pressure flowmeters are dependent on the system units selected for pressure:
 - Imperial units [inches H2O]
 - Metric units: [mbar]

Input:



Number with floating decimal point: 0.000...999999

Display:

.000 ft³/h
LOW SCALE-HIGH RANGE

FULL SCALE-HI RANGE

Set the full scale value for the high range transmitter analog input signal.
The value entered here must be identical to the value set for the flowmeter.

Note:

- The units for differential pressure flowmeters are dependent on the system units selected for pressure:
 - Imperial units [inches H2O]
 - Metric units: [mbar]

Input:







Number with floating decimal point: 0.000...999999

Display:

10000.00 ft³/h
FULL SCALE VALUE

6.8
FLOW INPUT
(Continued)

FLOW INPUT	
SWITCH UP DP	<p>Enter the value of delta P at which the unit will begin using the hi range delta P pressure transmitter signal.</p> <p>Input:</p> <div style="display: flex; align-items: center;">  Number with floating decimal point: 0.000...999999 </div> <p>Display: 0.000 in H2O SWITCH UP DP</p>
SWITCH DOWN DP	<p>Enter the value of delta P at which the unit will begin using the lo range delta P pressure transmitter signal.</p> <p>Input:</p> <div style="display: flex; align-items: center;">  Number with floating decimal point: 0.000...999999 </div> <p>Display: 0.000 in H2O SWITCH UP DP</p>
LOW FLOW CUTOFF	<p>Enter the low flow cutoff. This is used as a switchpoint for creep suppression. This can be used to prevent low flows from being registered.</p> <p>Input:</p> <div style="display: flex; align-items: center;">  Number with floating decimal point: 0.000...999999 </div> <p>Display: .000 ft³/h LOW FLOW CUTOFF</p>
K-FACTOR	<p>Enter the K-Factor of the flowmeter.</p> <p>Note:</p> <ul style="list-style-type: none"> • The K-Factor is expressed in pulses per unit volume (as defined by "total units") <p>Input:</p> <div style="display: flex; align-items: center;">  Number with floating decimal point: 0.001...999999 </div> <p>Display: .000 ft³/h LOW FLOW CUTOFF</p>
INLET PIPE BORE	<p>Enter the inlet pipe diameter or bore for the piping section upstream of the flow measurement device.</p> <p>Input:</p> <div style="display: flex; align-items: center;">  Number with floating decimal point: 0.001...1000.00 </div> <p>Display: 4.090 in INLET PIPE BORE</p>

**6.8
FLOW INPUT**
(Continued)

FLOW INPUT

ENTER BETA

Enter the geometric ratio for the square law device being used. This value is given by the manufacturer of the orifice plate, or other square law device.

Note:

"Beta" is only required for measuring gas or steam with some square law flowmeters.

Input:

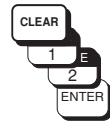

Number with fixed decimal point: 0.0000...1.0000

Display:

1.0000
ENTER BETA

CAL. DENSITY

Enter the calibration density. This is the fluid density upon which the flowmeter's calibration is based.

Input:

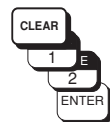

Number with floating decimal point in requested units: 0.000...10.000

Display:

8.3372 (#/gal)
CAL. DENSITY

6.8
FLOW INPUT
 (Continued)

FLOW INPUT
METER EXP. COEF.

The flowmeter pipe expands depending on the temperature of the fluid. This affects the calibration of the flowmeter. This submenu allows the user to enter an appropriate correction factor. This is given by the manufacturer of the flowmeter. This factor converts the changes in the measuring signal per degree variation from calibration temperature. The calibration temperature is entered into the flow computer to 70 F / 21 °C.

Some manufacturers use a graph or a formula to show the influence of temperature on the calibration of the flowmeter. In this case use the following equation to calculate the meter expansion coefficient:

$$K_{me} = \frac{1 - \frac{Q(T)}{Q(T_{CAL})}}{T - T_{CAL}} \cdot 1,000,000$$

K_{ME} Meter expansion coefficient
 $Q(T)$ Volumetric flow at temperature T resp. T_{CAL}
 T Average process temperature
 T_{CAL} Calibration temperature

Note:

- This correction should be set in either the flowmeter or in the flow computer.
- Entering the value "0.000" disables this function
- Value can be calculated from Fa factor

Input:

Number with floating decimal point:
 0.000...999.9 (e-6/°X)

Display:

27.111 (E-6/°F)
 METER EXP. COEF.

**6.8
FLOW INPUT
(Continued)**

FLOW INPUT

DP FACTOR

The DP-Factor describes the relationship between the flowrate and the measured differential pressure. The flowrate is computed according to one of the three following equations, depending on the selected flow equation:

Steam (or gas) mass flow:

$$M = \frac{K_{DP} \cdot \varepsilon_1 \cdot \sqrt{2 \cdot \Delta p \cdot \rho}}{1 - K_{ME} \cdot (T - T_{CAL})}$$

Liquid volume flow:

$$Q = \frac{K_{DP} \cdot \sqrt{(2 \cdot \Delta p) / \rho}}{(1 - K_{ME} \cdot (T - T_{CAL}))}$$

Gas corrected volume flow:

$$Q_{REF} = \frac{K_{DP} \cdot \varepsilon_1 \cdot \sqrt{2 \cdot \Delta p \cdot \rho}}{\rho_{REF} \cdot (1 - K_{ME} \cdot (T - T_{CAL}))}$$

M	Mass flow
Q	Volumetric flow
Q _{REF}	Corrected volumetric flow
K _{DP}	DP-Factor
ε ₁	Gas expansion factor (Y ₁)
T	Operating temperature
T _{CAL}	Calibration temperature
Δp	Differential pressure
ρ	Density at flowing conditions
K _{ME}	Meter expansion coefficient x 10 ⁻⁶
ρ _{REF}	Reference density

**6.8
FLOW INPUT**
 (Continued)

FLOW INPUT
DP FACTOR
 (Continued)

The DP-Factor (K_{DP}) can be entered manually or the flow computer can compute it for you. The information necessary for this calculation can be found on the sizing sheet from a flowmeter sizing program.

Note:

The following data must be entered before the flow computer can compute the DP-Factor.

- | | |
|------------------------------------|------------------------|
| 1. Flow equation | see "SYSTEM PARAMETER" |
| 2. Fluid Data | see "FLUID DATA" |
| 3. Beta | see "FLOW INPUT" |
| 4. Meter expansion coef. ref | see "FLOW INPUT" |
| 5. STP Ref. temperature*, pressure | see "OTHER INPUT" |
| 7. Inlet Pipe Bore | see "FLOW INPUT" |
| 8. Calibration Temp. | see "OTHER INPUT" |

* only for gas flow equations.

Entries:

CHANGE FACTOR? NO
 CHANGE FACTOR? YES

If "YES" the flow computer will prompt you further:



COMPUTE FACTOR? NO
 COMPUTE FACTOR? YES

If "NO": Enter DP FACTOR

If "YES": You will be prompted for the following:



ENTER DELTA P
 ENTER FLOWRATE
 ENTER DENSITY
 ENTER TEMPERATURE
 ENTER INLET PRESSURE
 ENTER ISENTROPIC EXP

**6.8
FLOW INPUT
(Continued)**
FLOW INPUT
**DP FACTOR
(Continued)**

The flow computer will then compute the gas expansion factor (ϵ_1), (Y_1) using one of the following equation:

Orifice Case:

$$Y_1 = \epsilon_1 = 1 - \left[(0.41 + 0.35 \beta^4) \cdot \frac{\Delta p}{\kappa \cdot p_1 \cdot 27.7} \right]$$

V-Cone, Venturi, Flow Nozzle, Wedge Case:

$$R = 1 - \frac{\Delta p}{27.7 \cdot p_1}$$

$$Y_1 = \epsilon_1 = \sqrt{\frac{(1 - \beta^4) \cdot \frac{\kappa}{\kappa - 1} \cdot R^{2/\kappa} \cdot (1 - R^{(\kappa-1)/\kappa})}{[(1 - (\beta^4 \cdot R^{2/\kappa})) \cdot (1 - R)]}}$$

Annubar, Pitot, Target Case;

$$Y_1 = \epsilon_1 = 1.0$$

- ϵ_1 Gas expansion factor
- β BETA (geometric ratio)
- Δp Differential pressure
- κ Isentropic exponent
- p_1 Inlet pressure (absolute)

NOTE: 27.7 is a units conversion constant from the absolute inlet pressure units to the differential pressure units. (27.7 is for psia to "H2O, use other units conversions as required.).

**6.8
FLOW INPUT
(Continued)**

FLOW INPUT

**DP FACTOR
(Continued)**

The DP-Factor (K_{DP}) is then computed using one of the following equations:

Steam:

$$K_{DP} = \frac{M \cdot (1 - K_{ME} \cdot (T - T_{CAL}))}{\varepsilon_1 \cdot \sqrt{2 \cdot \Delta p} \cdot \rho}$$

Liquid:

$$K_{DP} = \frac{Q \cdot (1 - K_{ME} \cdot (T - T_{CAL}))}{\sqrt{\frac{2 \cdot \Delta p}{\rho}}}$$

Gas:

$$K_{DP} = \frac{Q_{REF} \cdot \rho_{REF} \cdot (1 - K_{ME} \cdot (T - T_{CAL}))}{\varepsilon_1 \cdot \sqrt{2 \cdot \Delta p} \cdot \rho}$$

K_{DP}	DP-Factor
M	Mass flow
Q	Volumetric flow
Q_{REF}	Corrected volumetric flow
ε_1	Gas expansion factor
T	Operating temperature
T_{CAL}	Calibration temperature
Δp	Differential pressure
ρ	Density at flowing conditions
ρ_{REF}	Reference density

Note:

The computation accuracy can be enhanced by entering up to 16 values for Reynold's Number DP-Factor in a linearization table (see "LINEARIZATION"). Each DP-Factor can be calculated using the above procedure. For every calculation, a sizing sheet is required. The results have to be entered in the linearization table afterwards.

**LOW PASS
FILTER**

Enter the maximum possible frequency of a flowmeter with a digital output. Using the value entered here, the flow computer selects a suitable limiting frequency for low pass filter to help suppress interference from higher frequency signals.

Input:

Max. 5 digit number: 10...40000 (Hz):

Display:

40000 Hz
LOW PASS FILTER

**6.8
FLOW INPUT
(Continued)**

FLOW INPUT

LINEARIZATION

With many flowmeters, the relationship between the flowrate and the output signal may deviate from an ideal curve (linear or squared). The flow computer is able to compensate for this documented deviation using a linearization table. The appearance of the linearization table will vary depending on particular flowmeter selected.

Linear flowmeters with pulse output

The linearization table enables up to 16 different frequency & K-factor pairs. The frequency and corresponding K-factor are prompted for each pair of values. Pairs are entered in ascending order by frequency.

Linear Flowmeters with pulse outputs and a UVC Curve:

The linearization table enables up to 16 different Hz/cstks and K-Factor points. The Hz/cstks and corresponding K-Factors are prompted for each pair of values. Pairs are entered in ascending order by Hz/cstks.

Linear flowmeters with analog output

The linearization table enables up to 16 different flowrate & correction factor pairs. The flowrate and corresponding correction factor are prompted for each pair of values. The correction factor (K_f) is determined as follows.

$$K_f = \frac{\text{actual flowrate}}{\text{displayed flowrate}}$$

Linear/squared DP transmitters with analog output

The linearization table enables up to 16 different Reynold's Number an DP factor pairs. The Reynold's Number and corresponding DP factor are prompted for each pair of values.

Selection:



CHANGE TABLE? NO
CHANGE TABLE? YES

If "YES" the linearization table sequence of prompts will begin.

Example (for linear flowmeters with analog output)





Enter flow rate:
FLOW ft3/h 3.60
POINT 0

Entry of corresponding correction factor:
COR.FACTOR 1.0000
POINT 0

Note:

Enter "0" for the value of a pair (other than point 0) to exit the linearization table routine and use the values stored up to that point.

6.8
FLOW INPUT
(Continued)

FLOW INPUT	
FLOWMETER LOCATION	<p>Enter the Flowmeter Location</p> <p>Selection:</p> <p> Hot, Cold:</p> <p>Display: COLD FLOWMETER LOCATION</p>
BYPASS CAL. FACTOR	<p>Enter the Bypass Calibration Factor.</p> <p>Input:</p> <p> Max. 6 digit number: 0.000001...999999</p> <p>Display: 1.000000 BYPASS CAL. FACTOR</p>
BYPASS EAm FACTOR	<p>Enter the Bypass EAm Factor.</p> <p>Input:</p> <p> Max. 6 digit number: 0.000001...999999</p> <p>Display: 1.000000 BYPASS EAM FACTOR</p>
BYPASS DC FACTOR	<p>Enter the Bypass DC Factor.</p> <p>Input:</p> <p> Max. 6 digit number: 0.1...10.0</p> <p>Display: 1.000000 BYPASS DC FACTOR</p>
BYPASS Ym FACTOR	<p>Enter the Bypass Ym Factor.</p> <p>Input:</p> <p> Max. 6 digit number: 0.001...1.0</p> <p>Display: 1.000000 BYPASS YM FACTOR</p>
VIEW INPUT SIGNAL	<p>This feature is used to see the present value of the flow input signal. The type of electrical signal is determined by the flowmeter input signal type selection.</p> <p>Display: 150 Hz VIEW INPUT SIGNAL</p>
VIEW HIGH RANGE SIGNAL	<p>This feature is used to see the present value of the high range flow input signal. The type of electrical signal is determined by the flowmeter input signal type selection.</p> <p>Display: 4 mA VIEW HIGH RANGE SIGNAL</p>

**6.9
OTHER
INPUT**

OTHER INPUT

SELECT INPUT

In addition to the flow input, the flow computer provides two other inputs for temperature, density and/or pressure signals. In this submenu, select the particular input which is to be configured in the following submenus. Input 1 may also be used in conjunction with a steam trap monitor.

Selection:



- 1 (input 1: Temperature or Steam Trap Monitor)
- 2 (input 2: Pressure, Temperature 2, Density)

Display:

1
SELECT INPUT

INPUT SIGNAL

Determine the type of measuring signal produced by the temperature, pressure or density sensor.

Note:

When saturated steam is measured with only a pressure sensor, "INPUT 1 NOT USED" must be selected. If only a temperature sensor is used, "INPUT 2 NOT USED" must be selected.

Selection:

Input 1 (Temperature):



- INPUT 1 NOT USED, RTD TEMPERATURE, 4-20 TEMPERATURE, 0-20 TEMPERATURE, MANUAL TEMPERATURE*, 4-20 mA TRAP STATUS

Input 2 (Process pressure, Temperature 2, Density):



- INPUT 2 NOT USED, 4-20 PRESSURE (G), 0-20 PRESSURE (G), MANUAL PRESSURE*, 4-20 PRESSURE (ABS.), 0-20 PRESSURE (ABS.), RTD TEMPERATURE 2, 4-20 TEMPERATURE 2, 0-20 TEMPERATURE 2, MANUAL TEMPERAT. 2*, 4-20 DENSITY, 0-20 DENSITY, MANUAL DENSITY*

* Select this setting if a user defined fixed value for the corresponding measuring value is required.

Display:

4-20 TEMPERATURE
INPUT SIGNAL

**6.9
OTHER
INPUT**
(Continued)

OTHER INPUT

LOW SCALE VALUE

Set the low scale value for the analog current input signal (value for 0 or 4 mA input current). The value entered here must be identical to the value set in the pressure, temperature or density transmitter.

Input:



Number with fixed decimal point: -9999.99...+9999.99

Display: 32.00 of
 LOW SCALE VALUE

FULL SCALE VALUE

Set the full scale value for the analog current input signal (value for 20 mA input current). The value entered here must be identical to the value set in the pressure, temperature or density transmitter.

Input:



Number with fixed decimal point: -9999.99...+9999.99

Display: 752.00 of
 FULL SCALE VALUE

DEFAULT VALUE

A fixed value can be defined for the assigned variable (pressure, temperature, density). The flow computer will use this value in the following cases:

- In case of error (i.e. defective sensors). The flow computer will continue to operate using the value entered here.
- if "MANUAL TEMPERATURE", "MANUAL PRESSURE" or "MANUAL DENSITY" was selected for "INPUT SIGNAL".

Input:



Number with fixed decimal point: -9999.99...+9999.99

Display: 70.00 of
 DEFAULT VALUE

STP REFERENCE

Define the STP reference conditions (standard temperature and pressure) for the variable assigned to the input. Presently, standard conditions are defined differently depending on the country and application.



Input:



Number with fixed decimal point:
-9999.99...+9999.99

Display: 60.00 of
 STP REFERENCE

**6.9
OTHER
INPUT**
(Continued)

OTHER INPUT	
BAROMETRIC PRESS.	<p>Enter the actual atmospheric pressure. When using gauge pressure transmitters for determining gas pressure, the reduced atmospheric pressure above sea level is then taken into account.</p> <p>Input:</p> <p> Number with floating decimal point: 0.0000...10000.0</p> <p>Display: 1.013 bara BAROMETRIC PRESS.</p>
CALIBRATION TEMP.	<p>Enter the temperature at which the flowmeter was calibrated. This information is used in the correction of temperature induced effects on the flowmeter body dimensions.</p> <p>Input:</p> <p> Number with fixed decimal point: -9999.99...+9999.99</p> <p>Display: 68.00 of CALIBRATION TEMP.</p>
VIEW INPUT SIGNAL	<p>This feature is used to see the present value of the compensation input signal. The type of electrical signal is determined by the compensation input signal type selection.</p> <p>Display: 20 mA VIEW INPUT SIGNAL</p>
TRAP ERROR DELAY	<p>Enter the TRAP ERROR DELAY (cold trap error) in HH:MM format. An alarm will only be activated if the trap is detected as continuously being in the abnormal states for a time period greater than this TRAP ERROR DELAY time.</p> <p>Display: HH:MM TRAP ERROR DELAY</p>
TRAP BLOWING DELAY	<p>Enter the TRAP BLOWING DELAY (trap stuck open) in HH:MM format. An alarm will only be activated if the trap is detected as continuously being in the abnormal states for a time period greater than this TRAP BLOWING DELAY time.</p> <p>Display: HH:MM TRAP BLOWING DELAY</p>

6.10
PULSE
OUTPUT

PULSE OUTPUT

ASSIGN PULSE OUTPUT

Assign the pulse output to a measured or calculated totalizer value.

Selection:



HEAT TOTAL, MASS TOTAL,
CORRECTED VOL. TOTAL,
ACTUAL VOLUME TOTAL

Display:

ACTUAL VOLUME TOTAL
ASSIGN PULSE OUTPUT

6.10
PULSE
OUTPUT
(Continued)

PULSE OUTPUT

PULSE TYPE

The pulse output can be configured as required for an external device (i.e. remote totalizer, etc.).

- ACTIVE:** Internal power supply used (+24V).
- PASSIVE:** External power supply required.
- POSITIVE:** Rest value at 0V (active high).
- NEGATIVE:** Rest value at 24V (active low) or external power supply.

Active:

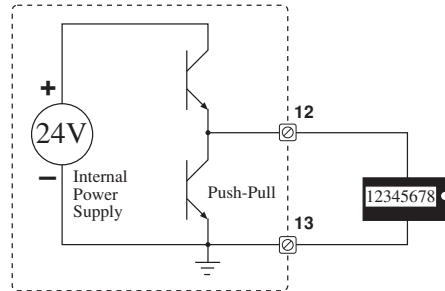

Passive:

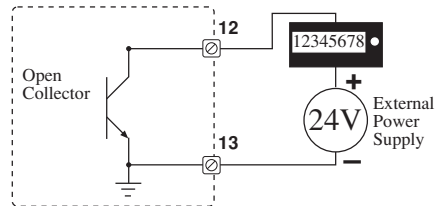

Positive Pulse:

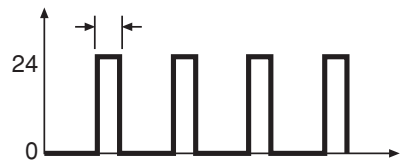

Negative Pulse:

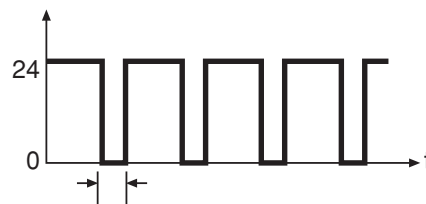

Selection:



PASSIVE-NEGATIVE, PASSIVE-POSITIVE,
ACTIVE-NEGATIVE, ACTIVE-POSITIVE

Display:

PASSIVE/POSITIVE
PULSE TYPE

**6.10
PULSE
OUTPUT**
(Continued)

PULSE OUTPUT

PULSE VALUE

Define the flow quantity per output pulse. This is expressed in units per pulse (i.e. ft³ / pulse).

Note:
Ensure that the max. flowrate (full scale value) and the pulse value entered here agree with one another. The max. possible output frequency is 50Hz. The appropriate pulse value can be determined as follows:

$$\text{Pulse value} > \frac{\text{estimated max. flowrate (full scale)}/\text{sec}}{\text{required max. output frequency}}$$

Input:
 Number with floating decimal point: 0.001...10000.0

Display:
1.000 ft³/P
PULSE VALUE

PULSE WIDTH

Set the pulse width required for external devices. The pulse width limits the max. possible output frequency of the pulse output. For a certain output frequency, the max permissible pulse width can be calculated as follows:

$$\text{Pulse width} < \frac{1}{2 \cdot \text{max. output frequency (Hz)}}$$

Input:
 Number with floating decimal point: 0.01...9.999 s (seconds)

Display:
.01 s
PULSE WIDTH

SIMULATION FREQ.

Frequency signals can be simulated in order to check any instrument that is connected to the pulse output. The simulated signals are always symmetrical (50/50 duty cycle).





Note:

- The simulation mode selected affects the frequency output. The flow computer is fully operational during simulation.
- Simulation mode is ended immediately after exiting this submenu.

Selection:
 OFF, 0.0 Hz, 0.1 Hz, 1.0 Hz, 10 Hz, 50 Hz

Display:
OFF
SIMULATION FREQ>

**6.11
CURRENT
OUTPUT**

CURRENT OUTPUT	
SELECT OUTPUT	<p>Select the current output to be configured. The flow computer offers two current outputs.</p> <p>Selection:</p> <p> 1 (Current output 1) 2 (Current output 2)</p> <p>Display: 1 SELECT OUTPUT</p>
ASSIGN CURRENT OUT	<p>Assign a variable to the current output.</p> <p>Selection:</p> <p> HEAT FLOW, MASS FLOW, COR. VOLUME FLOW, VOLUME FLOW, TEMPERATURE, TEMPERATURE 2, DELTA TEMPERATURE, PRESSURE, DENSITY, PEAK DEMAND, DEMAND LAST HOUR</p> <p>Display: VOLUME FLOW ASSIGN CURRENT OUT.</p>
CURRENT RANGE	<p>Define the 0 or 4 mA low scale current value. The current for the scaled full scale value is always 20 mA.</p> <p>Selection:</p> <p> 0-20 mA, 4-20 mA, NOT USED</p> <p>Display: 4-20 mA CURRENT RANGE</p>
LOW SCALE	<p>Set the low scale value to the 0 or 4 mA current signal for the variable assigned to the current output.</p> <p>Input:</p> <p> Number with floating decimal point: -999999...+999999</p> <p>Display: .000 ft3/h LOW SCALE VALUE</p>
FULL SCALE	<p>Set the full scale value to the 20 mA current signal for the variable assigned to the current output.</p> <p>Input:</p> <p> Number with floating decimal point: -999999...+999999</p> <p>Display: 1000.00 ft3/h FULL SCALE VALUE</p>

**6.11
CURRENT
OUTPUT**
(Continued)

CURRENT OUTPUT	
TIME CONSTANT	<p>Select the time constant to determine whether the current output signal reacts quickly (small time constant) or slowly (large time constant) to rapidly changing values (i.e. flowrate). The time constant does not affect the behavior of the display.</p> <p>Input:</p> <div style="display: flex; align-items: center;"> <div style="border: 1px solid black; padding: 2px; margin-right: 5px;"> <small>TOTAL</small> <div style="display: flex; justify-content: space-between; width: 100%;"> 1 E </div> <div style="display: flex; justify-content: space-between; width: 100%;"> 2 </div> </div> <p>Max. 2 digit number: 0...99</p> <p>Display: 1</p> <p style="text-align: center;">TIME CONSTANT</p> </div>
CURRENT OUT VALUE	<p>Display the actual value of the current output.</p> <p>Display: 0.000 mA</p> <p style="text-align: center;">CURRENT OUT VALUE</p>
SIMULATION CURRENT	<p>Various output currents can be simulated in order to check any instruments which are connected.</p> <p>Note:</p> <ul style="list-style-type: none"> The simulation mode selected affects only the selected current output. The flow computer is fully operational during simulation. Simulation mode is ended immediately after exiting this submenu. <p>Selection:</p> <div style="display: flex; align-items: center;"> <div style="margin-right: 5px;">  </div> <p>OFF, 0 mA, 2 mA, 4 mA, 12 mA, 20 mA, 25 mA</p> </div> <p>Display: OFF</p> <p style="text-align: center;">SIMULATION CURRENT</p>

6.12
RELAYS

RELAYS

SELECT RELAY

Set relay output to be configured. Two or three relay outputs are available.

Selection:



1 (Relay 1)

2 (Relay 2)

3 (Relay 3, optional)

Display: 1

SELECT RELAY

RELAY FUNCTION

Both relays (1 and 2, and optional 3rd relay) can be assigned to various functions as required:

Alarm functions
Relays activate upon exceeding limit setpoints. Freely assignable to measured or calculated variables or totalizers.

Malfunction
Indication of instrument failure, power loss, etc.

Pulse output
The relays can be defined as additional pulse outputs for totalizer values such as heat, mass, volume or corrected volume.

Wet steam alarm
The flow computer can monitor pressure and temperature in superheated steam applications continuously and compare them to the saturated steam curve. When the degree of superheat (distance to the saturated steam curve) drops below 5 °C, the relay switches and the message "WET STEAM ALARM" is displayed.

NOTE:
Relay response time is affected by the value entered for display damping. The larger the display damping value, the slower the relay response time will be. This is intended to prevent false triggering of the relays. Enter a display damping factor of zero (0) for fastest relay response time.

Selection:
Different selections are available depending on the flow equation and type of transmitter selected.



HEAT TOTAL, MASS TOTAL,
CORRECTED VOL. TOTAL,
ACTUAL VOLUME TOTAL, HEAT FLOW,
MASS FLOW, COR. VOL. FLOW,
VOLUME FLOW, TEMPERATURE,
TEMPERATURE 2, DELTA TEMPERATURE, PRESSURE,
DENSITY, WET STEAM ALARM, MALFUNCTION, PEAK
DEMAND, DEMAND LAST HOUR

Display: VOLUME FLOW
RELAY FUNCTION

6.12
RELAYS
(Continued)

RELAYS

RELAY MODE

Set when and how the relays are switched "ON" and "OFF". This defines both the alarm conditions and the time response of the alarm status.

Selection:



- HI ALARM, FOLLOW
- LO ALARM, FOLLOW
- HI ALARM LATCH
- LO ALARM LATCH
- RELAY PULSE OUTPUT

Note:

- For relay functions "MALFUNCTION" and "WET STEAM ALARM". There is no difference between the modes "HI....." and "LO.....":
(i.e. HI ALARM FOLLOW = LO ALARM FOLLOW, HI ALARM LATCH = LOW ALARM LATCH)
- Relay mode "RELAY PULSE OUTPUT" defines the relay as an additional pulse output.

Display: HI ALARM, FOLLOW
 RELAY MODE

LIMIT SETPOINT

After configuring a relay for "Alarm indication" (limit value), the required setpoint can be set in this submenu. If the variable reaches the set value, the relay switches and the corresponding message is displayed.
Continuous switching near the setpoint can be prevented with the "HYSTERESIS" setting.

Note:

- Be sure to select the units (SYSTEM UNITS) before entering the setpoint in this submenu.
- Normally open or normally closed contacts are determined when wiring.

Input:



Number with floating decimal point: -999999...+999999

Display: 99999.0 ft3/h
 LIMIT SETPOINT 1

**6.12
RELAYS**
(Continued)

RELAYS

PULSE VALUE

Define the flow quantity per output pulse if the relay is configured for "RELAY PULSE OUTPUT".. This is expressed in units per pulse (i.e. ft³ / pulse).

Note:

Ensure that the max. flowrate (full scale value) and the pulse value entered here agree with one another. The max. possible output frequency is 5Hz. The appropriate pulse value can be determined as follows:

$$\text{Pulse value} > \frac{\text{estimated max. flowrate (full scale)/sec}}{\text{required max. output frequency}}$$

Input:



Number with floating decimal point: 0.001...1000.0

Display:

1.000 ft³/P
PULSE VALUE

PULSE WIDTH

Enter the pulse width. Two cases are possible:

Case A: Relay set for "MALFUNCTION" or limit value

The response of the relay during alarm status is determined by selecting the pulse width.

- Pulse width = 0.0 s (Normal setting)
Relay is latched during alarm conditions.
- Pulse width = 0.1...9.9 s (special setting)
Relay will energize for selected duration, independent of the cause of the alarm. This setting is only used in special cases (i.e. for activating signal horns).

Case B: Relay set for "RELAY PULSE OUTPUT"

Set the pulse width required for the external device. The value entered here can be made to agree with the actual flow amount and pulse value by using the following:

$$\text{Pulse width} < \frac{1}{2 \cdot \text{max. output frequency (Hz)}}$$

Input:





Number with floating decimal point:
0.01...9.99 s (pulse output)
0.00...9.99 s (all other configurations)





Display:

.01 s
PULSE WIDTH

6.12
RELAYS
(Continued)

RELAYS	
HYSTERESIS	<p>Enter a hysteresis value to ensure that the "ON" and "OFF" switchpoints have different values and therefore prevent continual and undesired switching near the limit value.</p> <p>Input:</p> <p> Number with floating decimal point: 0.000...999999</p> <p>Display: 0.000 psia HYSERESIS</p>
RESET ALARM	<p>The alarm status for the particular relay can be cancelled here if (for safety reasons) the setting "....., LATCH" has been selected in the submenu "RELAY MODE". This ensures that the user is actively aware of the alarm message.</p> <p>Note:</p> <ul style="list-style-type: none"> • When in the HOME position, press the ENTER key to acknowledge and clear alarms. • The alarm status can only be permanently cancelled if the cause of the alarm is removed. <p>Selection:</p> <p> RESET ALARM? NO RESET ALARM? YES</p> <p>Display: RESET? NO RESET ALARM</p>
SIMULATE RELAY	<p>As an aid during start-up, the relay output may be manually controlled independent of it's normal function.</p> <p>Selection:</p> <p> NORMAL, ON, OFF</p> <p>Display: NORMAL SIMULATE RELAY</p>

6.13
COMMUNICATION

COMMUNICATION	
RS-232 USAGE	<p>The flow computer can be connected via RS-232 interface to a personal computer or printer.</p> <p>Selection:</p> <p> COMPUTER, PAGER, PRINTER, MODEM</p> <p>Display: COMPUTER RS-232 USAGE</p>
DEVICE ID	<p>Enter the unique unit I.D. tag number for the flow computer if a number of flow computers are connected to the same interface.</p> <p>Selection:</p> <p> Max. 2 digit number: 0...99</p> <p>Display: 1 DEVICE ID</p>
BAUD RATE	<p>Enter the baud rate for serial communication between the flow computer and a personal computer, modem, pager or printer.</p> <p>Selection:</p> <p> 9600, 2400, 1200, 300</p> <p>Display: 9600 BAUD RATE</p>
PARITY	<p>Select the desired parity. The setting selected here must agree with the parity setting for the computer, modem, pager or printer.</p> <p>Selection:</p> <p> NONE, ODD, EVEN</p> <p>Display: NONE PARITY</p>
HANDSHAKE	<p>The control of data flow can be defined. The setting required is determined by the handshaking of the printer.</p> <p>Selection:</p> <p> NONE, HARDWARE</p> <p>Display: NONE HANDSHAKE</p>

6.13
COMMUNICATION
(Continued)

COMMUNICATION

PRINT LIST

Select the variables or parameters which are to be logged or printed via the RS-232 interface.

Selection (Procedure):



CHANGE? NO
CHANGE? YES

If YES selected, the available variables are displayed one after another. Only some of the following options are available depending on the flow equation selected:



Store option
advance to next



Print?

PRINT HEADER?	NO(YES)
INSTRUMENT TAG?	NO(YES)
FLUID TYPE?	NO(YES)
TIME?	NO(YES)
DATE?	NO(YES)
TRANSACTION NO.?	NO(YES)
HEAT FLOW?	NO(YES)
HEAT TOTAL?	NO(YES)
HEAT GRAND TOTAL?	NO(YES)
MASS FLOW?	NO(YES)
MASS TOTAL?	NO(YES)
MASS GRAND TOTAL?	NO(YES)
COR. VOLUME FLOW?	NO(YES)
COR.VOL.GRAND TOTAL?	NO(YES)
VOLUME FLOW?	NO(YES)
VOLUME TOTAL?	NO(YES)
VOL. GRAND TOTAL?	NO(YES)
TEMPERATURE?	NO(YES)
TEMPERATURE 2?	NO(YES)
DELTA TEMPERATURE?	NO(YES)
PROCESS PRESSURE?	NO(YES)
DENSITY?	NO(YES)
SPEC. ENTHALPY?	NO(YES)
DIFF. PRESSURE?	NO(YES)
ERRORS?	NO(YES)
ALARMS?	NO(YES)
PEAK DEMAND?	NO(YES)
DEMAND LAST HOUR?	NO(YES)
PEAK TIME STAMP?	NO(YES)
PEAK DATE STAMP?	NO(YES)
TRAP MONITOR?	NO(YES)

"YES" + ENTER: Parameter is added to the print list

"NO" + ENTER: parameter is not printed

After the last option the display advances to the next submenu.

**6.13
COMMUNICATION
(Continued)**

COMMUNICATION

PRINT INITIATE

Datalogger and/or printing variables and parameters over the serial RS-232 interface can be initiated at regular intervals (INTERVAL) or daily at a fixed time (TIME OF DAY) or by front key depression.

Note:

Printing can always be initiated by pressing the PRINT key.

Selection:



NONE, TIME OF DAY, INTERVAL, ENABLE PRINT KEY

Display:

TIME OF DAY
PRINT INITIATE

DATALOG ONLY

Select YES or NO for Datalog Only prompt.

Selection:



YES - Data is logged but no information is sent on print event.
NO - Data is logged and immediately transmitted.

Display:

YES
DATALOG ONLY

PRINT INTERVAL

Define a time interval. Variables and parameters will be periodically logged at regular intervals of this value of time. The setting "00:00" deactivates this feature.

Input:



Time value in hours & minutes (HH:MM).

Display:

00:00
PRINT INTERVAL

PRINT TIME

Define the time of day that variables and parameters will be logged out daily.

Input:



Time of day in hours & minutes (HH:MM).

Display:

00:00
PRINT TIME

DATALOG FORMAT

Define the Datalog Format.

Selection:











DATABASE - Data sets sent in comma separated variable format.
PRINTER - Individual output variables sent with text label and units suitable for printing.

Display:

PRINTER
DATALOG FORMAT

6.13
COMMUNICATION
(Continued)

COMMUNICATION	
SEND INC. TOT. ONLY	<p>Select YES or NO for Send Inc. Tot. Only</p> <p>Selection:</p> <p> YES - Unit will send Inc. Tot. Only  NO - Unit will not send Inc. Tot. Only</p> <p>Display: YES SEND INC. TOT. ONLY</p>
INC ONLY SCALER	<p>Enter multiplying factor for Inc Only Scaler</p> <p>Selection:</p> <p> X1, X10, X100, X1000</p> <p>Display: X1 INC ONLY SCALER</p>
CLEAR DATALOG	<p>Select YES or NO for Clear Datalog</p> <p>Selection:</p> <p> YES - Unit will clear datalog contents  NO - Unit will not clear datalog contents</p> <p>Display: YES CLEAR DATALOG</p>
MODEM CONTROL (Modem)	<p>Select YES or NO for Modem Control.</p> <p>Selection:</p> <p> YES - Modem initialization and dialing commands are sent during transactions.  NO - Modem initialization and dialing commands are NOT sent during transactions.</p> <p>Display: YES MODEM CONTROL</p>
DEVICE MASTER (Modem or Pager)	<p>Select YES or NO for Device Master</p> <p>Selection:</p> <p> YES - Sets sole master device responsible for initializing pager or modem.  NO - Device will not be used to initialize pager or modem.</p> <p>Display: YES DEVICE MASTER</p>

6.13
COMMUNICATION
(Continued)

COMMUNICATION

MODEM AUTO ANSWER (Modem)

Select YES or NO for Modem Auto Answer

Selection:



- YES - Modem will answer incoming calls.
- NO - Modem will not answer incoming calls.

Display:

YES
MODEM AUTO ANSWER

CALL OUT NO (Modem or Pager)

Define a Call Out Number. Enter the telephone number, pager number or email address to be called.

Input:



max. 16 digit phone number

Display:

CALL OUT NO

CALL OUT TIME (Modem or Pager)

Define the Call Out Time. Enter scheduled call out time (24 hr format), if you want the unit to call out to a remote PC.

Input:



Time of day in hours & minutes (HH:MM).

Display:

00:00
CALL OUT TIME

CALL ON ERROR (Modem or Pager)

Select YES or NO for Call On Error prompt.

Selection:



- YES - Unit will call out to remote PC if a designated CSI error occurs.
- NO - Unit will not call out to remote PC if error occurs.

Display:

YES
CALL ON ERROR

NUMBER OF REDIALS (Modem or Pager)

Enter the Number Of Redials desired in the event of a busy signal or communication problem.

Input:



max. 2 digit number

Display:

3
NUMBER OF REDIALS



6.13
COMMUNICATION
(Continued)

COMMUNICATION

**HANG UP IF INACTIVE
(Modem)**

Select YES or NO for Hang Up If Inactive

Selection:

YES - Unit will hang up if remote PC fails to respond within several minutes after connection is established.

NO - Unit will not hang up if remote PC fails to respond after connection is established.

Display:

YES
HANG UP IF INACTIVE

**PAGER PIN NUMBER
(Pager)**

Enter Pager Pin Number for local transceiver.

Input:



max. 16 digit number



Display:

PAGER PIN NUMBER

**DESTINATION TYPE
(Pager)**

Select the Destination Type

Selection:

E-MAIL - Data will be sent via pager and internet.

PAGER - Data will be sent to another pager or pager mailbox.

Display:

E-MAIL
DESTINATION TYPE



**REGISTER PAGER
(Pager)**

Select YES or NO for Register Pager prompt.

Note:

A message will indicate if registration is successful.

Selection:

YES - Will result in unit and pager attempting to register with local paging network provider (Skytel)

NO - Advance to next menu item

Display:

YES
REGISTER PAGER

6.13
COMMUNICATION
(Continued)

COMMUNICATION

ERROR MASK
(Pager or Modem)

Select YES or NO for Change Error Mask? prompt

Selection:



Display:

00:00
CALL OUT TIME

If YES selected, define the conditions that you wish to call out on. The possible conditions are displayed one after another.



Store option
advance to next



Change?

- | | |
|---------------------|---------|
| POWER FAILURE | NO(YES) |
| WATCHDOG TIMEOUT | NO(YES) |
| COMMUNICATION ERROR | NO(YES) |
| CALIBRATION ERROR | NO(YES) |
| PRINT BUFFER FULL | NO(YES) |
| TOTALIZER ERROR | NO(YES) |
| WET STEAM ALARM | NO(YES) |
| OFF FLUID TABLE | NO(YES) |
| FLOW IN OVERRANGE | NO(YES) |
| INPUT1 OVERRANGE | NO(YES) |
| INPUT2 OVERRANGE | NO(YES) |
| FLOW LOOP BROKEN | NO(YES) |
| LOOP1 BROKEN | NO(YES) |
| LOOP2 BROKEN | NO(YES) |
| RTD 1 OPEN | NO(YES) |
| RTD 1 SHORT | NO(YES) |
| RTD 2 OPEN | NO(YES) |
| RTD 2 SHORT | NO(YES) |
| PULSE OUT OVERRUN | NO(YES) |
| out 1 OUT OF RANGE | NO(YES) |
| out 2 OUT OF RANGE | NO(YES) |
| RELAY 1 HIGH ALARM | NO(YES) |
| RELAY 1 LOW ALARM | NO(YES) |
| RELAY 2 HIGH ALARM | NO(YES) |
| RELAY 2 LOW ALARM | NO(YES) |
| RELAY 3 HIGH ALARM | NO(YES) |
| RELAY 3 LOW ALARM | NO(YES) |
| TRAP ERROR | NO(YES) |
| TRAP BLOWING | NO(YES) |
| INPUT 3 OVERRANGE | NO(YES) |
| INPUT 3 BROKEN | NO(YES) |
| 24VDC OUT ERROR | NO(YES) |
| PULSE IN ERROR | NO(YES) |
| INPUT 1 Vin ERROR | NO(YES) |
| INPUT 1 Iin ERROR | NO(YES) |
| INPUT 2 Iin ERROR | NO(YES) |
| INPUT 2 RTD ERROR | NO(YES) |
| INPUT 3 Iin ERROR | NO(YES) |
| INPUT 3 RTD ERROR | NO(YES) |
| PULSE OUT ERROR | NO(YES) |
| out 1 ERROR | NO(YES) |
| out 2 ERROR | NO(YES) |
| RELAY 1 ERROR | NO(YES) |
| RELAY 2 ERROR | NO(YES) |
| RS-232 ERROR | NO(YES) |
| A/D MALFUNCTION | NO(YES) |
| PROGRAM ERROR | NO(YES) |
| SETUP DATA LOST | NO(YES) |
| TIME CLOCK LOST | NO(YES) |
| DISPLAY MALFUNCTION | NO(YES) |
| RAM MALFUNCTION | NO(YES) |
| DATALOG LOST | NO(YES) |

6.13
COMMUNICATION
 (Continued)

COMMUNICATION

CLP PROGRESS
(Pager)

This is a diagnostic cell for the TWP transceiver. The display shows Clip (CLP) Progress. This is a diagnostic cell which tracks progress of two way paging data exchange. If problems are encountered during use, note the stage at which problems occurred prior to seeking technical help.

Display: -124xm Ocur 54stg
 CLP PROGRESS

STG DEFINITIONS

- | | |
|---|--|
| 0) IDLE
1) WAITING FOR GET MESSGE STATUS
2) WAITING TO REQUEST DIR INFO
3) RECIEVING DIR INFO
4) MAKE A REQUEST FOR MESSAGE
5) START MESSAGE DOWNLOAD
6) WAIT TO REPLY TO A MESSAGE
7) WAIT TO SEND FINAL ACK
8) INTIALIZE XMODEM
9) PARSE DATA
10) SEND RESPONSE
11)WAIT HERE UNTIL ALL BLOCKS ARE SENT AND THEN ACK
12)WAIT FOR FINAL ACK
13)WAIT FOR TRANSMISSION TO START and get status
14) WAIT FOR SKYTEL RESPONSE AND GET STATUS
15) WHEN STATUS IS IN CHECK IF GOOD then delete OR REPEAT
16)when delete done reset
20)INTIALIZE XMODEM
21)PARSE PRINT LIST DATA
22) SEND XMODEM BLOCK
23) WAIT HERE FOR ALL XMODEM TO BE SENT
24)WAIT FOR EOT TO BE ACKNOWLEDGE
25)WAIT FOR TRANSMISSION TO START and get status
26) WAIT FOR SKYTEL TO RESPOND and get status
27) IF TRANSMISSION IS GOOD END ELSE REPEAT.
30)INTIALIZE XMODEM
31)PARSE PRINT MAINTENCE DATA
32) SEND XMODEM BLOCK
33) WAIT HERE FOR ALL XMODEM TO BE SENT
34)WAIT FOR EOT TO BE ACKNOWLEDGE
35)WAIT FOR TRANSMISSION TO START and get status
36) WAIT FOR SKYTEL TO RESPOND and get status
37) IF TRANSMISSION IS GOOD END ELSE REPEAT.
40)INTIALIZE XMODEM
41)PARSE PRINT SETUP DATA | 42) SEND XMODEM BLOCK
43) WAIT HERE FOR ALL XMODEM TO BE SENT
44)WAIT FOR EOT TO BE ACKNOWLEDGE
45)WAIT FOR TRANSMISSION TO START and get status
46) WAIT FOR SKYTEL TO RESPOND and get status
47) IF TRANSMISSION IS GOOD END ELSE REPEAT.
50) MODEM STRING FOR SELF CONTACT
51)SEND STRING
52) WAIT FOR ACK SEND EOT OR REPEAT
53)WAIT FOR FINAL ACK
54)WAIT FOR TRANSMISSION TO START AND GET STATUS
55)WAIT FOR SKYTEL RESPONSE AND GET STATUS
56)WAIT FOR STATUS INFO TO BE RECIEVED THEN CHECK IF GOOD
57)WAIT FOR SKYTEL MESSAGE
58) WAITING FOR GET MESSGE STATUS
59) WAITING TO REQUEST DIR INFO
60) RECIEVING DIR INFO
61) DELETE MESSAGE
62) RESET CLP
70)INTIALIZE XMODEM
71)PARSE PRINT SETUP DATA
72) SEND XMODEM BLOCK
73) WAIT HERE FOR ALL XMODEM TO BE SENT
74)WAIT FOR EOT TO BE ACKNOWLEDGE
75)WAIT FOR TRANSMISSION TO START and get status
76) WAIT FOR SKYTEL TO RESPOND and get status
77) IF TRANSMISSION IS GOOD END ELSE REPEAT.
80)INTIALIZE XMODEM
81)PARSE PRINT SETUP DATA
82) SEND XMODEM BLOCK
83) WAIT HERE FOR ALL XMODEM TO BE SENT
84)WAIT FOR EOT TO BE ACKNOWLEDGE
85)WAIT FOR TRANSMISSION TO START and get status
86) WAIT FOR SKYTEL TO RESPOND and get status
87) IF TRANSMISSION IS GOOD END ELSE REPEAT.
100)RESETTING OF THE OF CLP STAGE
101)UNIT IS LOST TRY TO RESYNC.
102) POWER UP DELAY |
|---|--|

6.13
COMMUNICATION
(Continued)

COMMUNICATION

**MAX BLOCK SIZE
(Pager)**

Enter Maximum Block Size. Data transmissions are first partitioned into 128 character blocks. Up to the recommended maximum number of blocks can be sent in each transmission. Smaller block counts are more likely to be sent successfully than larger block counts. 3 is recommended for preliminary block size.

Input:



number from 0 to 15

Display:

3
MAX BLOCK SIZE

**INITIALIZE PAGER
(Pager)**

Select YES or NO for Initialize Pager prompt. Select YES and press ENTER to locally initialize the pager once installation has been completed. A message will indicate if initialization is successful. Initialize Pager before attempting to register pager.

Selection:



YES, NO

Display:

YES
INITIALIZE PAGER

6.14
SERVICE &
ANALYSIS

SERVICE & ANALYSIS

EXAMINE AUDIT TRAIL

Two counters contain the number of times the calibration and/or configuration parameters have been changed. Changes in important calibration and configuration data are registered and displayed ("electronic stamping"). These counters advance automatically. These counters cannot be reset so that unauthorized changes can be identified.

Example:

CAL 015 CFG 076

Display: CAL 015 CFG 076
 EXAMINE AUDIT TRAIL

ERROR LOG

A list of errors that have occurred can be viewed and cleared.

Selection:

VIEW? NO

VIEW? YES

If "YES" is selected the error log can be viewed and errors individually cleared (if editing enabled with Service Code).

Display: CLEAR? NO
 POWER FAILURE

SOFTWARE VERSION

Display the software version of the flow computer. (Contact local agent for upgrade information)

Example:

02.00.14

Display: 02.00.14
 SOFTWARE VERSION

HARDWARE VERSION

Display the hardware version of the flow computer. (Contact local agent for upgrade information)

Example:

01.00.01

Display: 01.00.01
 HARDWARE VERSION

**6.16
SERVICE &
ANALYSIS**
(Continued)

SERVICE & ANALYSIS

**PERFORM
CALIBRATION**

NOTE:
This menu item will only appear if editing is enabled with Service Code.

This feature allows the calibration of the units inputs and outputs.

CAUTION:

The calibration should only be performed by qualified technicians. The calibration procedure requires the use of precision Voltage & Current sources, a frequency generator, a 100Ω resistor (± 0.1%), an ammeter, an ohmmeter and a frequency counter. If calibration fails, use the "Restore Factory Calibration" feature.

Selection:



NO, YES

Display: PERFORM? YES
 CALIBRATION

**VOLTAGE INPUT
CALIBRATION**

Connect your voltage source to (+) Pin 2 and (-) Pin 4.

**LEARN
0.0 V
(Pin 2)**

Apply 0.0 Volts. Press enter to learn 0.0 Volts.

Display: RESULT: 0.000 V
 LEARN 0.0 V PIN 2

**LEARN
10.0 V
(Pin 2)**

Apply 10.0 Volts. Press enter to learn 10.0 Volts.

Display: RESULT: 10.000 V
 LEARN 10.0 V PIN 2

**CURRENT INPUT
CALIBRATION**

Connect your current source to (+) Pin 2 and (-) Pin 4.

**LEARN
0.0 mA
(Pin 2)**

Apply 0.0 mA. Press enter to learn 0.0 mA.

Display: RESULT: 0.000 mA
 LEARN 0.0 mA PIN 2

**LEARN
20.0 mA
(Pin 2)**

Apply 20.0 mA. Press enter to learn 20.0 mA.

Display: RESULT: 20.000 mA
 LEARN 20.0 mA PIN 2

**LEARN
0.0 mA
(Pin 3)**

Connect your current source to (+) Pin 3 and (-) Pin 4.

Apply 0.0 mA. Press enter to learn 0.0 mA.

Display: RESULT: 0.000 mA
 LEARN 0.0 mA PIN 3

**LEARN
20.0 mA
(Pin 3)**

Apply 20.0 mA. Press enter to learn 20.0 mA.

Display: RESULT: 20.000 mA
 LEARN 20.0 mA PIN 3

**6.14
SERVICE &
ANALYSIS
(Continued)**

SERVICE & ANALYSIS																																					
CURRENT INPUT CALIBRATION (continued)	<p>Connect your current source to (+) Pin 7 and (-) Pin 4.</p> <table border="0" style="width: 100%;"> <tr> <td style="vertical-align: top; width: 20%;">LEARN 0.0 mA (Pin 7)</td> <td style="vertical-align: top; width: 30%;">Apply 0.0 mA. Press enter to learn 0.0 mA.</td> <td style="vertical-align: top; width: 50%;">Display:</td> </tr> <tr> <td></td> <td></td> <td style="text-align: right;"> RESULT: 0.000 mA LEARN 0.0 mA PIN 7 </td> </tr> <tr> <td style="vertical-align: top;">LEARN 20.0 mA (Pin 7)</td> <td style="vertical-align: top;">Apply 20.0 mA. Press enter to learn 20.0 mA.</td> <td style="vertical-align: top;">Display:</td> </tr> <tr> <td></td> <td></td> <td style="text-align: right;"> RESULT: 20.000 mA LEARN 20.0 mA PIN 7 </td> </tr> </table> <hr/> <p>Connect your current source to (+) Pin 11 and (-) Pin 4.</p> <table border="0" style="width: 100%;"> <tr> <td style="vertical-align: top; width: 20%;">LEARN 0.0 mA (Pin 11)</td> <td style="vertical-align: top; width: 30%;">Apply 0.0 mA. Press enter to learn 0.0 mA.</td> <td style="vertical-align: top; width: 50%;">Display:</td> </tr> <tr> <td></td> <td></td> <td style="text-align: right;"> RESULT: 0.000 mA LEARN 0.0 mA PIN 11 </td> </tr> <tr> <td style="vertical-align: top;">LEARN 20.0 mA (Pin 11)</td> <td style="vertical-align: top;">Apply 20.0 mA. Press enter to learn 20.0 mA.</td> <td style="vertical-align: top;">Display:</td> </tr> <tr> <td></td> <td></td> <td style="text-align: right;"> RESULT: 20.000 mA LEARN 20.0 mA PIN 11 </td> </tr> </table> <hr/> <p>RTD INPUT CALIBRATION</p> <p>Connect a 100Ω resistor between Pins 6 & 7 and place a jumper wire between Pins 5 & 6.</p> <table border="0" style="width: 100%;"> <tr> <td style="vertical-align: top; width: 20%;">Temperature Input (Pins 5, 6 & 7)</td> <td style="vertical-align: top; width: 30%;">Press enter to learn RTD resistance on Pins 5, 6 & 7.</td> <td style="vertical-align: top; width: 50%;">Display:</td> </tr> <tr> <td></td> <td></td> <td style="text-align: right;"> RESULT: 100.00 ohm LEARN RTD PIN 5-6-7 </td> </tr> </table> <hr/> <p>Connect a 100Ω resistor between Pins 10 & 11 and place a jumper wire between Pins 9 & 10.</p> <table border="0" style="width: 100%;"> <tr> <td style="vertical-align: top; width: 20%;">Temperature 2 Input (Pins 9, 10 & 11)</td> <td style="vertical-align: top; width: 30%;">Press enter to learn RTD resistance on Pins 9, 10 & 11.</td> <td style="vertical-align: top; width: 50%;">Display:</td> </tr> <tr> <td></td> <td></td> <td style="text-align: right;"> RESULT: 100.00 ohm LEARN RTD PIN 9-10-11 </td> </tr> </table>	LEARN 0.0 mA (Pin 7)	Apply 0.0 mA. Press enter to learn 0.0 mA.	Display:			RESULT: 0.000 mA LEARN 0.0 mA PIN 7	LEARN 20.0 mA (Pin 7)	Apply 20.0 mA. Press enter to learn 20.0 mA.	Display:			RESULT: 20.000 mA LEARN 20.0 mA PIN 7	LEARN 0.0 mA (Pin 11)	Apply 0.0 mA. Press enter to learn 0.0 mA.	Display:			RESULT: 0.000 mA LEARN 0.0 mA PIN 11	LEARN 20.0 mA (Pin 11)	Apply 20.0 mA. Press enter to learn 20.0 mA.	Display:			RESULT: 20.000 mA LEARN 20.0 mA PIN 11	Temperature Input (Pins 5, 6 & 7)	Press enter to learn RTD resistance on Pins 5, 6 & 7.	Display:			RESULT: 100.00 ohm LEARN RTD PIN 5-6-7	Temperature 2 Input (Pins 9, 10 & 11)	Press enter to learn RTD resistance on Pins 9, 10 & 11.	Display:			RESULT: 100.00 ohm LEARN RTD PIN 9-10-11
LEARN 0.0 mA (Pin 7)	Apply 0.0 mA. Press enter to learn 0.0 mA.	Display:																																			
		RESULT: 0.000 mA LEARN 0.0 mA PIN 7																																			
LEARN 20.0 mA (Pin 7)	Apply 20.0 mA. Press enter to learn 20.0 mA.	Display:																																			
		RESULT: 20.000 mA LEARN 20.0 mA PIN 7																																			
LEARN 0.0 mA (Pin 11)	Apply 0.0 mA. Press enter to learn 0.0 mA.	Display:																																			
		RESULT: 0.000 mA LEARN 0.0 mA PIN 11																																			
LEARN 20.0 mA (Pin 11)	Apply 20.0 mA. Press enter to learn 20.0 mA.	Display:																																			
		RESULT: 20.000 mA LEARN 20.0 mA PIN 11																																			
Temperature Input (Pins 5, 6 & 7)	Press enter to learn RTD resistance on Pins 5, 6 & 7.	Display:																																			
		RESULT: 100.00 ohm LEARN RTD PIN 5-6-7																																			
Temperature 2 Input (Pins 9, 10 & 11)	Press enter to learn RTD resistance on Pins 9, 10 & 11.	Display:																																			
		RESULT: 100.00 ohm LEARN RTD PIN 9-10-11																																			

6.14
SERVICE &
ANALYSIS
(Continued)

SERVICE & ANALYSIS	
ANALOG OUTPUT 1 CALIBRATION (Pins 14 & 16)	Connect your Ammeter (current meter) to (+) Pin 14 and (-) Pin 16.
ADJ 4 mA (Pins 14 & 16)	Observe the reading on the ammeter. Using the numeric keys, enter the actual reading (in mA) and press enter. Display: ACTUAL? 4.025 mA ADJ 4mA PIN 14-16
ADJ 20 mA (Pins 14 & 16)	Observe the reading on the ammeter. Using the numeric keys, enter the actual reading (in mA) and press enter. Display: ACTUAL? 20.017 mA ADJ 20mA PIN 14-16
ANALOG OUTPUT 2 CALIBRATION (Pins 15 & 16)	Connect your Ammeter (current meter) to (+) Pin 15 and (-) Pin 16.
ADJ 4 mA (Pins 15 & 16)	Observe the reading on the ammeter. Using the numeric keys, enter the actual reading (in mA) and press enter. Display: ACTUAL? 4.041 mA ADJ 4mA PIN 15-16
ADJ 20 mA (Pins 15 & 16)	Observe the reading on the ammeter. Using the numeric keys, enter the actual reading (in mA) and press enter. Display: ACTUAL? 20.006 mA ADJ 20mA PIN 15-16
FREQUENCY OUTPUT SIMULATION (Pins 12 & 13)	Connect your frequency meter to (+) Pin 12 and (-) Pin 13. This feature is used to check the pulse output. Calibration is not performed. Selection:  OFF, 50 Hz, 10 Hz, 1.0 Hz, 0.1 Hz, 0.0 Hz Display: OFF SIMULATION FREQ.

**6.14
SERVICE &
ANALYSIS**
(Continued)

SERVICE & ANALYSIS	
RELAY TEST RELAY 1 TEST (Pins 17, 18 & 19)	Using the ohmmeter, check continuity between pins (17 & 18) and 18 & 19 while turning ON & OFF Relay 1 using the up/down arrow keys. Press enter when test is completed. Display: RELAY 1: OFF TEST RELAY 1
RELAY 2 TEST (Pins 20, 21 & 22)	Using the ohmmeter, check continuity between pins 20 & 21 and (21 & 22) while turning ON & OFF Relay 2 using the up/down arrow keys. Press enter when test is completed. Display: RELAY 2: OFF TEST RELAY 2
RELAY 3 TEST (Pins 19 & 20)	Using the ohmmeter, check continuity between pins 19 & 20 while turning ON & OFF Relay 2 using the up/down arrow keys. Press enter when test is completed. Display: RELAY 3: OFF TEST RELAY 3
PULSE INPUT TEST INPUT FREQUENCY (Pins 2 & 4)	Using the frequency generator, apply a frequency to (+) Pin 2 and (-) Pin 4. Compare the displayed frequency with the input frequency. Display: 0.000 Hz INPUT FREQUENCY
SAVE AS FACTORY CALIBRATION	The calibration procedure is complete. You may now choose to save this calibration as the Factory Calibration. Display: NO SAVE AS FACTORY CAL.
RESTORE FACTORY CALIBRATION	If you are not satisfied with the calibration results you can restore the last saved Factory Calibration. Display: NO RESTOR FACT. CALIB.
SET NEXT CALIBRATION DATE	This feature allows you to enter the next date you would like the unit to be calibrated. This is very useful when components must be periodically calibrated. This date is included on Print Maint. and Setup Reports. Display: 10 DEC 1999 NEXT CALIBRATION
PRINT MAINT. REPORT	This feature allows you to transmit a maintenance report over the RS-232 port for printout. The report includes error messages and calibration information Display: NO PRINT MAINT. REPORT

**6.14
SERVICE &
ANALYSIS**
(Continued)

SERVICE & ANALYSIS	
PRINT SYSTEM SETUP	<p>This feature allows the units setup parameters to be printed to a connected printer.</p> <p>Display: NO PRINT SYSTEM SETUP</p>
SELF CHECK	<p>This feature starts the self-test of the flow computer. A test is internally conducted on the EEPROM, A/D Converter, Time/Date clock, Display and several other hardware circuits.</p> <p>Display: RUN? NO SELF CHECK</p>
<p>SERVICE TEST (Not available with 3 Relay option)</p> <p>NOTE: This will only appear if editing is enabled with the Service Code.</p>	<p>The Service Test requires a special calibration apparatus that connects to the rear terminals of the unit. This is used to determine whether the flow computer or the field wiring is faulty. The calibration apparatus may be purchased from your local distributor.</p> <p>Display: RUN? NO SERVICE TEST</p>

7. Principle Of Operation

General Operation

7.1 General:

The EA403 Flow Computer uses several internal calculations to compute the compensated flow based on specific data input. Several computations are performed to arrive at the uncompensated flow, temperature, pressure, density and viscosity. This information is then used to compute the Corrected Volume Flow, Mass Flow or Heat Flow.

Square Law Flowmeter Considerations

7.2 Square Law Flowmeter Considerations:

Head class flowmeters are supplied by the manufacturers with a 4-20 mA output span which is already in flow units. The EA403 permits the user to enter this flowmeter information directly. However, closely associated with this information is the density that was assumed during flowmeter calibration. This information must also be input if the user is to obtain maximum accuracy.

It is assumed that the user has the printout from a standardized sizing program for the particular device he will be using. Such standardized printouts list all the necessary information which the user will then be prompted for.

Several specialized flow equations are listed that are not intended for the standard unit but to be offered to appropriate OEMs or as special order items. These are designated by a “†”.

Note concerning Fluid Information

The user will be prompted for Fluid Information during the setup of the instrument. See Appendix A for the properties of several common fluids.

Flow Equations

7.3 Flow Equations:

7.3.1 Flow Input Computation

Flow Input Computation:

Linear

$$\text{Input Flow} = [\% \text{ input span} \cdot (\text{flow FS} - \text{flow low scale})] + \text{flow low scale}$$

Square Law without External SQRT Extractor

$$\text{delta P} = [(\% \text{ input span}) \cdot (\text{flow FS} - \text{flow low scale})] + \text{flow low scale}$$

Square Law with External SQRT Extractor

$$\text{delta P} = [(\% \text{ input span})^2 \cdot (\text{flow FS} - \text{flow low scale})] + \text{flow low scale}$$

NOTE: For stacked differential pressure option, the appropriate input sensor signal is used in calculations at all times to maximize accuracy.

**7.3.2
Pressure
Computation**
Pressure Input:
General Case

$$P_f = [\% \text{ input span} \cdot (\text{Pres full scale} - \text{Pres low scale})] + \text{Pres low scale}$$

Gauge Case

$$P_f = P_f + \text{Barometric}$$

Manual Case or In Event of Fault

$$P_f = \text{Pressure Default Value}$$

**7.3.3
Temperature
Computation**
Temperature Computation:
General Case

$$T_f = [\% \text{ input span} \cdot (\text{Temp full scale} - \text{Temp low scale})] + \text{Temp low scale}$$

RTD Case

$$T_f = f(\text{measured input resistance})$$

Manual Case or In Event of Fault

$$T_f = \text{Temperature Default Value}$$

Delta Temp Case

$$\text{Delta Temp} = T_2 - T_1 \quad \text{Flowmeter location} = \text{cold}$$

$$\text{Delta Temp} = T_1 - T_2 \quad \text{Flowmeter location} = \text{hot}$$

**7.3.4
Density/Viscosity
Computation**
Density Computation:
Water Case

$$\text{density_water} = \text{density}(T_f)$$

Liquid Case

$$\text{density} = \text{reference density} \cdot (1 - \text{Therm.Exp.Coef.} \cdot (T_f - T_{\text{ref}}))^2$$

Steam Case

$$\text{density} = 1 / \text{specific volume}(T_f, P_f)$$

Gas Case

$$\text{density} = \text{reference density} \cdot \frac{P_f}{P_{\text{ref}}} \cdot \frac{(T_{\text{ref}} + 273.15)}{(T_f + 273.15)} \cdot \frac{Z_{\text{ref}}}{Z_f}$$

NOTE: For Natural Gas:

$\frac{Z_{\text{ref}}}{Z_f}$ is determined by NX-19 when this selection is supplied and selected.

NOTE: Therm.Exp.Coef is ($\times 10^{-6}$)

**7.3.4
Density/Viscosity
Computation
(continued)**
Viscosity (cP) Computation:
Liquid Case

$$\text{cP viscosity} = A \cdot \exp \frac{B}{(T_f + 459.67)}$$

NOTE:

$$\text{Viscosity cS} = \frac{\text{viscosity (in cP)}}{\left(\frac{\text{flowing density}}{\text{density of water @ 4°C}} \right)}$$

Gas Case

$$\text{cP viscosity} = A \cdot (T_f + 459.67)^B$$

Steam Case

$$\text{cP viscosity} = f(T_f, P_f)$$

**7.3.5
Corrected
Volume Flow
Computation**
Corrected Volume Flow Computation:
Liquid Case

$$\text{std. volume flow} = \text{volume flow} \cdot (1 - \text{Therm.Exp.Coef.} \cdot (T_f - T_{ref}))^2$$

Gas Case

$$\text{std. volume flow} = \text{volume flow} \cdot \frac{P_f}{P_{ref}} \cdot \frac{(T_{ref} + 273.15)}{(T_f + 273.15)} \cdot \frac{Z_{ref}}{Z_f}$$

NOTE: For Natural Gas:

$$\frac{Z_{ref}}{Z_f} \quad \text{is determined by NX-19 when this selection is supplied and selected.}$$

Natural Gas NX-19 Equation: The NX-19 (1963) natural gas state equations are widely used in custody transfer applications. Over most normal measurement ranges, 500 to 5000 psia (3.5 to 10.4 MPa) and -10 to 100°F (-23 to 38°C), the NX-19 equation will compute the gas compressibility factor to within 0.2% of the values computed by the newer AGA-8 state equation.

The ranges over which the NX-19 equation applies are:

Pressure P_G	To 5000 psig (10.34 MPa gauge)
Temperature T_f	-40 to 240°F (-40 to 116°C)
Specific Gravity G	0.554 to 1.0
CO ₂ and N ₂	0 to 15%

Our Flow Computer uses the Specific Gravity method to first obtain the adjusted temperature and pressure before entering the state equation. This method calculates the adjusted pressure and temperature from the mole fractions of carbon dioxide and nitrogen as

$$P_{adj} = \frac{156.47 P_G}{160.8 - 7.22 G_g + 100X_{CO_2} - 39.2X_{N_2}} \quad \text{psig}$$

Where X_{CO_2} and X_{N_2} are the mole fractions of carbon dioxide and nitrogen, respectively. The adjusted temperature is defined by

$$T_{adj} = \frac{226.29 (T_f + 460)}{99.15 + 211.9 G_g - 100X_{CO_2} - 168.1 X_{N_2}} \quad \text{°F}$$

**7.3.5
Corrected
Volume Flow
Computation
(continued)**

After calculating the adjusted pressure and temperature, the mixture's pressure and temperature *correlations parameters* are calculated by

$$P = \frac{P_{\text{adj}} + 14.7}{1000} \qquad T = \frac{T_{\text{adj}}}{500}$$

The compressibility factor is then calculated by first determining

$$\begin{aligned} m &= 0.0330378T^{-2} - 0.0221323T^{-3} + 0.0161353T^{-5} \\ n &= (0.265827T^{-2} + 0.0457697T^{-4} - 0.133185T^{-1})m^{-1} \\ B &= \frac{3 - mn^2}{9mp^2} \\ b &= \frac{9n - 2mn^3}{54mp^2} - \frac{E}{2mp^2} \\ D &= [b + (b^2 + B^3)^{0.5}]^{1/3} \end{aligned}$$

Where E is a function of the pressure p and temperature T correlation parameters. The equations for E are given in the following table for the designated regions. The following compressibility Z_f is determined by

$$Z_f = \frac{1}{B/D - D + n/3p}$$

NX-19 Natural Gas Regions and E Equations

Ranges		E
P	T	
0 to 2	1.09 to 1.40	E_1
0 to 1.3	0.84 to 1.09	E_2
1.3 to 2.0	0.88 to 1.09	E_3
1.3 to 2.0	0.84 to 0.88	E_4
2.0 to 5.0	0.84 to 0.88	E_5
2.0 to 5.0	0.88 to 1.09	E_6
2.0 to 5.0	1.09 to 1.32	E_7
2.0 to 5.0	1.32 to 1.40	E_8

$$\begin{aligned} T_a &= T - 1.09 & T_b &= 1.09 - T \\ E_1 &= 1 - 0.00075p^{2.3} \exp(-20T_a) - 0.0011T_a^{0.5}p^2(2.17 + 1.4T_a^{0.5} - p)^2 \\ E_2 &= 1 - 0.00075p^{2.3} [2 - \exp(-20T_b)] - 1.317T_b^4p(1.69 - p^2) \\ E_3 &= 1 - 0.00075p^{2.3} [2 - \exp(-20T_b)] + 0.455(200T_b^6 - 0.03249T_b \\ &\quad + 2.0167T_b^2 - 18.028T_b^3 + 42.844T_b^4)(p - 1.3)[1.69(2)^{1.25} - p^2] \\ E_4 &= 1 - 0.00075p^{2.3} [2 - \exp(-20T_b)] + 0.455(200T_b^6 - 0.03249T_b \\ &\quad + 2.0167T_b^2 - 18.028T_b^3 + 42.844T_b^4)(p - 1.3)[1.69(2)^{1.25 + 80(0.88 - T)^2} - p^2] \\ E_5 &= E_4 - X & E_6 &= E_3 - X & E_7 &= E_1 - X & E_8 &= E_7 - X_1 \\ X &= A(T - 2) + A_1(p - 2)^2 + A_2(p - 2)^3 + A_3(p - 2)^4 \\ X_1 &= (p - 1.32)^2(p - 2)[3 - 1.483(p - 2) - 0.1(p - 2)^2 + 0.0833(p - 2)^3] \\ A &= 1.7172 - 2.33123T - 1.56796T^2 + 3.47644T^3 - 1.28603T^4 \\ A_1 &= 0.016299 - 0.028094T - 0.48782T^2 - 0.78221T^3 + 0.27839T^4 \\ A_2 &= -0.35978 + 0.51419T + 0.165453T^2 - 0.52216T^3 + 0.19687T^4 \\ A_3 &= 0.075255 - 0.10573T - 0.058598T^2 + 0.14416T^3 - 0.054533T^4 \end{aligned}$$

When NX-19 is used for custody transfer applications, the base compressibility factor is calculated by:

$$Z_b = \left(1 + \frac{0.00132}{T^{3.25}} \right)^{-2}$$

**7.3.6
Mass Flow
Computation**
Mass Flow Computations:

$$\text{mass flow} = \text{volume flow} \cdot \text{density}$$

**7.3.7
Comb. Heat Flow
Computation**
Combustion Heat Flow Computations:

$$\text{combustion heat flow} = \text{mass flow} \cdot \text{combustion heating value}$$

**7.3.8
Heat Flow
Computation**
Heat Flow Computation:
Steam Heat

$$\text{heat flow} = \text{mass flow} \cdot \text{total heat steam}(T_f, P_f)$$

Steam Net Heat

$$\text{heat flow} = \text{mass flow} \cdot [\text{total heat steam}(T_f, P_f) - \text{heat saturated water}(P_f)]$$

Steam Delta Heat

$$\text{heat flow} = \text{mass flow} \cdot [\text{total heat saturated steam}(P_f) - \text{heat water}(T_f)]$$

**7.3.9
Sensible Heat
Flow
Computation**
Sensible Heat Flow:
Special Case for Water

$$\text{heat flow} = \text{mass flow}(T_f) \cdot \text{enthalpy}(T_f)$$

**7.3.10
Liquid Delta Heat
Computation**
Liquid Delta Heat:
General Case

$$\text{heat flow} = \text{mass flow} \cdot \text{specific heat} \cdot (T_2 - T_f)$$

Water Case

$$\text{heat flow} = \text{mass flow}(T_f) \cdot [\text{enthalpy}(T_2) - \text{enthalpy}(T_f)]$$

**7.3.11
Expansion Factor
Computation for
Square Law Flow-
meters**
Expansion Factor Computation for Square Law Flowmeters:

In the following Equations, delta P is assumed in ("H₂O), P_f is in PSIA, 27.7 is a PSIA to ("H₂O) units conversion.

Liquid Case

$$Y = 1.0$$

Gas, Steam Case
Orifice Case

$$Y = 1.0 - (0.41 + 0.35 \cdot B^4) \cdot \frac{\text{delta P}}{\text{isentropic exponent} \cdot P_f \cdot 27.7}$$

V-Cone, Venturi, Flow Nozzle, Wedge Case:

$$R = 1 - \frac{\Delta p}{27.7 \cdot p_f}$$

$$Y = \sqrt{\frac{(1 - \beta^4) \cdot \frac{\kappa}{\kappa - 1} \cdot R^{2/\kappa} \cdot (1 - R^{(\kappa-1)/\kappa})}{[(1 - (\beta^4 \cdot R^{2/\kappa})) \cdot (1 - R)]}}$$

NOTE: An equivalent formula is used by V-Cone flowmeter types.

Target, Annubar, Pitot Case:

$$Y = 1.0$$

**7.3.12
Uncompensated
Flow Computa-
tion**
Uncompensated Flow Computation:

Pulse, Linear Case

$$\text{volume flow} = \frac{\text{input frequency} \cdot \text{Time Scaling Factor}}{\text{K-Factor} \cdot [1 - \text{Meter Exp.Coeff.} \cdot (T_f - T_{cal})]}$$

Analog, Linear Case

$$\text{volume flow} = \frac{\text{Measured Input Flow}}{[1 - \text{Meter Exp.Coeff.} \cdot (T_f - T_{cal})]}$$

Square Law Case

$$\text{volume flow} = \frac{\text{DP Factor}}{[1 - \text{Meter Exp.Coeff.} \cdot (T_f - T_{cal})]} \cdot Y \cdot \left[\frac{2 \cdot \Delta P}{\text{density}} \right]^{1/2}$$

Square Law, Target Flowmeter Case

$$\text{volume flow} = \text{input flow} \cdot \frac{\sqrt{\text{density cal.}}}{\sqrt{\text{density flowing}}}$$

Pulse, Linearization Case

$$\text{volume flow} = \frac{\text{input frequency} \cdot \text{Time Scaling Factor}}{\text{K-Factor(Hz)} \cdot [1 - \text{Meter Exp.Coeff.} \cdot (T_f - T_{cal})]}$$

Analog, Linearization Case

$$\text{volume flow} = \frac{\text{Input Flow} \cdot \text{Correction Factor (Input Flow)}}{[1 - \text{Meter Exp.Coeff.} \cdot (T_f - T_{cal})]}$$

Square Law, Linearization Case

$$\text{volume flow} = \frac{\text{DP Factor(RN)}}{[1 - \text{Meter Exp.Coeff.} \cdot (T_f - T_{cal})]} \cdot Y \cdot \left[\frac{2 \cdot \Delta P}{\text{density}} \right]^{1/2}$$

Pulse, UVC Case

$$\text{volume flow} = \frac{\text{input frequency} \cdot \text{Time Scaling Factor}}{\text{K-Factor (Hz/cstks)} \cdot [1 - \text{Meter Exp.Coeff.} \cdot (T_f - T_{cal})]}$$

Shunt Flow Bypass Flowmeter

$$\text{volume flow} = \frac{\text{input frequency} \cdot 457 \cdot \text{Epa} \cdot Y_m}{\sqrt{\text{flowing density}} \cdot \text{DC} \cdot \text{bypass calibration factor}}$$

Gillflo Flowmeter

$$\text{volume flow at flowing conditions} = \text{input flow at design conditions} \cdot \sqrt{\frac{\text{calibration density}}{\text{flowing density}}}$$

NOTE: Therm.Exp.Coef is 10^{-6}

7.4 Computation of the DP Factor

It is assumed that the user has the printout from a standardized sizing program for the particular device he will be using. Such standardized printouts list all the necessary information which the user will then be prompted for by the instrument or diskette.

It is also important that the user select the flow equation to be used and either select or enter the following items:

Flowmeter Type
 The fluid type or the fluid properties applicable to the fluid to be measured
 Beta, Meter Exp. Coeff., Inlet Pipe Bore
 Reference Conditions of temperature, pressure, Z and calibration temperature

The user is prompted for the following:

mass flow or volume flow or corrected volume flow as indicated by the flow equation
 Differential Pressure
 Inlet Pressure
 Temperature
 Density
 Isentropic Exponent

The unit then computes the following results corresponding to the user entry conditions and appropriate methods:

Y

Finally the DP Factor is computed as follows:

Steam Case

$$\text{DP Factor} = \frac{\text{mass flow} \cdot [1 - \text{Meter Exp.Coeff.} \cdot (T_f - T_{cal})]}{Y \cdot [2 \cdot \text{delta P} \cdot \text{density}]^{1/2}}$$

Liquid Case

$$\text{DP Factor} = \frac{\text{volume} \cdot [1 - \text{Meter Exp.Coeff.} \cdot (T_f - T_{cal})]}{\left[\frac{2 \cdot \text{delta P}}{\text{density}} \right]^{1/2}}$$

Gas Case

$$\text{DP Factor} = \frac{\text{Std.Vol.Flow} \cdot \text{ref density} \cdot [1 - \text{Meter Exp.Coeff.} \cdot (T_f - T_{cal})]}{Y \cdot [2 \cdot \text{delta P} \cdot \text{density}]^{1/2}}$$

Application Hint:

The user may reenter this DP Factor multiple times to assist him in assembling the table points of DP Factor and Reynold's Number necessary to construct a 16 point table for the meter run.

NOTE: Meter Exp.Coef is (x10⁻⁶)

8. RS-232 Serial Port

8.1 RS-232 Port Description:

The EA403 has a general purpose RS-232 Port which may be used for any one of the following purposes:

Transaction Printing, Data Logging, Remote Metering by Modem or Two Way Paging (optional), Computer Communication Link, Configuration by Computer, Print System Setup, Print Calibration/Malfunction History

8.2 Instrument Setup by PC's over Serial Port

A Diskette program is provided with the EA403 that enables the user to rapidly configure the EA403 using a Personal Computer. Included on the diskette are common instrument applications which may be used as a starting point for your application. This permits the user to have an excellent starting point and helps speed the user through the instrument setup.

8.3 Operation of Serial Communication Port with Printers

EA403's RS-232 channel supports a number of operating modes. One of these modes is intended to support operation with a printer in metering applications requiring transaction printing, data logging and/or printing of calibration and maintenance reports.

For transaction printing, the user defines the items to be included in the printed document. The user can also select what initiates the transaction print generated as part of the setup of the instrument. The transaction document may be initiated via a front panel key depression. In data logging, the user defines the items to be included in each data log as a print list. The user can also select when or how often he wishes a data log to be made. This is done during the setup of the instrument as either a time of day or as a time interval between logging.

The system setup and maintenance report list all the instrument setup parameters and usage for the current instrument configuration. In addition, the Audit trail information is presented as well as a status report listing any observed malfunctions which have not been corrected.

The user initiates the printing of this report at a designated point in the menu by pressing the print key on the front panel.

8.4 EA403 RS-232 Port Pinout

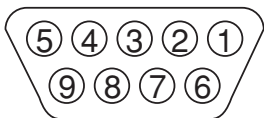

- 1 Handshake Line (cd in)
- 2 Transmit (tx)
- 3 Receive (rx)
- 4 Do Not Use
- 5 Ground
- 6 Do Not Use
- 7 RTS out
- 8 Do Not Use
- 9 DC Power Out*

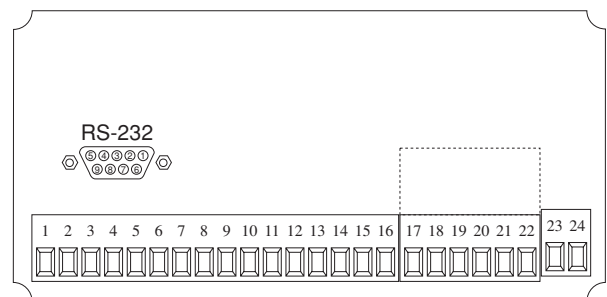

* 8 VDC Power supplied on Pin 9 to power modem or two way pager

9. Flow Computer Setup Software

The EA403 setup program provides for configuring, monitoring and controlling a EA403 unit. Sample applications are stored in disk files. The setup program calls these *Templates*. You can store the setup from the program's memory to either the EA403 (*Downloading* the file) or to a disk file (*Saving* the file) for later usage. Similarly you can load the setup in program memory from either a disk file (*Opening* a file) or from the EA403 unit (*Uploading* a file).

The program can monitor outputs from the unit while it is running.

The program can reset alarms and totalizers.

The peak demand may be reset when the option is supplied.

For assistance there are mini-helps at the bottom of each screen in the program. There is also context sensitive help available for each screen accessible by pressing the F1 key.

9.1 System Requirements:

IBM PC or compatible with 386 or higher class microprocessor

4 MB RAM

3 MB free disk space

VGA or higher color monitor at 640 x 480

Microsoft® Windows™ 3.1 or 3.11 or Windows 95/98™ or higher

Communication Port - RS-232

RS-232 Cable (customer supplied)

9.2 Cable and Wiring Requirements:

The serial communication port on your PC is either a 25 pin or 9 pin connector. No cabling is supplied with the setup software. A cable must be purchased separately or made by the user. It is recommended to purchase a serial cable which matches the available communication port on you PC and a 9 pin male connection for the EA403 serial port.

9.3 Installation for Windows™ 3.1 or 3.11

The Setup Software includes an installation program which copies the software to your hard drive.

Insert Setup Disk 1 in a floppy drive.

In the Program Manager, click File, and then select Run.

NOTE: For Windows 95™ Click the Start button, select Run and proceed as follows:

Type the floppy drive letter followed by a colon (:), and a backslash (\), and the word setup.

For Example:

a:\setup

Follow the instructions on your screen.

9.4 Using the Flow Computer Setup Software

The setup software window consists of several menu "Tabs". Each tab is organized into groups containing various configuration and/or monitoring functions. To view the tab windows, simply click on the tab. The previous tab window will be hidden as the new tab window is brought to the foreground.

Caution: It is required that the EA403 unit which is being configured be kept in the operating mode while using the setup diskette. If not, uncertainty exists as to what information will be retained when the session is concluded.

9.5 File Tab

The File Tab has three sections. Any of the options on this tab can also be accessed from the File submenu.

The **Template Section** provides for opening and saving templates. The *Save* and *Save As* buttons provide the standard Windows functionality for dealing with files. The *Open* button is used to open existing templates.

The *Open* option allows for creating custom templates using the existing template in memory as the starting point. Assign a new name for this template. The template will be saved under this new name.

A typical scenario using the setup program would be the following:

- Open up a predefined template from the supplied list
- Choose 'Save As' to save this to a new file name
- Proceed to customize the template by making any changes that are needed
- Save the template to disk (if you want to reuse this template)
- Download the template to an attached unit.

The **Communications with EA403 Section** allows the user to upload the setup from the unit or download the program's current template to the unit.

The **Print (report) Section** allows the user to:

1. Configure the current Windows printer through the Select Printer option.
2. Print a Maintenance Report through the PC's printer using the Print Maintenance option.
3. Print the current setup through the PC's printer using Print Setup option.

9.6 Setup Tab

The Setup tab is where the majority of the EA403 instrument setup modifications are done. The Setup tab is divided into five sections.

System Section: Parameters, Display, Units

Input Section: Flow, Fluid, Compensation Inputs

Output Section: Pulse, Currents

Relay Section: Relays

Other Settings Section: Administration, Communication, Printing

NOTE: Many setup items are enabled or disabled depending on previous setup selections. It is important to work your way through the above list in the order shown. Be sure to verify your selections when you are through programming to insure that no settings were changed automatically.

9.7 View Tab

The View Tab screen allows for viewing selected group items on the PC in a similar format to that shown on the unit display. Data from the following groups can be viewed in the List of Values section:

- Process Parameters (i.e. rate, temperature)
- Totalizers (i.e. total, grand total)
- Input Signals
- Analog Output
- Error Status
- EA403 Software Version Information

The setup software assumes the current setup has been uploaded from the flow computer into the PC. It is important that the setup program and the EA403 unit are using the same setup information at all times or the data will be inconsistent. It is best to upload or download the setup before using this feature to synchronize the setups.

Error Log

Data from the error logger is viewed in a separate Error Log section on the screen.

To start the viewer, first check the boxes of items to view and then click the start button. The data will appear in the appropriate sections and will be continuously updated. The refresh rate is dependent on the number of items that are being viewed and the baud rate of the connection. Data in the List of Values section can be collapsed by clicking on the 'minus' sign in front of the group title. The data can be expanded by clicking on the 'plus' sign in front of the group title. If a group is collapsed and data in the group changes on refresh, the group will automatically expand. Data in the Error Log section does not expand or collapse. Changing the view items requires stopping the current viewing, checking the new selections and then restarting the viewer.

If communication errors occur while reading data from the EA403 device, the word 'Error' will appear in place of the actual value. If the connection to the EA403 is lost, the viewer will time out with a message saying the device is not responding.

The viewer will attempt to communicate with the EA403 device matching the device ID set in the communications screen. If you are having trouble establishing communication, compare settings for the PC and the flow computer. Also verify the connections between the PC and flow computer.

9.8 Misc. Tab

This tab has three sections: Tools, Actions and Options.

The tools section contains various system administration activities such as creating/modifying the initial sign-on screen or create print headers.

The Actions section is used to send commands to the EA403 unit.

Reset Totalizers, Reset Alarms, Simulations, Self Check, Reset Peak Demand (if equipped)

The Options section has the following selections:

Language Translations, Network Card Configuration
Additional capabilities may be provided in the future.

10. Glossary of Terms

Access Code

A numeric password which is entered by a user attempting to gain entry to change setup parameters.

AGA-3

A empirical flow equation applicable to orifice and several other square law flowmeters.

AGA-5

A gas flow equation for computing the combustion heat flow from measured volume flow, temperature and pressure as well as stored gas properties.

AGA-7

A gas flow equation for pulse producing, volumetric flowmeters which computes the equivalent flow at reference conditions from the measurements made at flowing line conditions.

Assign Usage

A menu selection during the setup of the instrument which selects the intended usage for the input/output.

Barometric Pressure

An entry of the average, local atmospheric pressure at the altitude or elevation of the installation. (typically 14.696 psia)

Beta

A important geometric ratio for a square law flowmeters.

Calibration

An order sequence of adjustments which must be performed in order for the equipment to operate properly.

Calibration Temperature

The temperature at which a flow sensor was calibrated on a test fluid.

Combustion Heat

The energy released by a fluid fuel during combustion .

Default

A value to be assumed for manual inputs or in the event of a failure in a input sensor.

Display Damping

An averaging filter constant used to smooth out display bounce.

DP Factor

A scaling constant for a square law flowmeter.

Error Log

A historical record which captures errors which have occurred.

Flow Equation

A recognized relationship between the process parameters for flow, temperature, pressure and density used in flow measurements.

Galvanic Isolation

Input and or output functions which do not share a conductive ground or common connection between them.

Gas Cor. Vol Eq.

An equation where the corrected volume flow of gas at STP is computer from measured volume flow, temperature and pressure as well as stored gas properties.

Gas Comb. Heat Eq.

An equation where the combustion heat flow of gas is computer from measured volume flow, temperature and pressure as well as stored gas properties.

Gas Mass Eq.

An equation where the mass flow of gas is computer from measured volume flow, temperature and pressure as well as stored gas properties.

Flowing Z-Factor

The mean Z-Factor under flowing conditions of temperature and pressure for a specific gas.

10. Glossary of Terms (Continued)

Full Scale

The value of the process variable at the full scale or maximum input signal.

Inlet Pipe Bore

The internal pipe diameter upstream of the flow measurement element.

Isentropic Exponent

A property of a gas or vapor utilized in orifice meter calculations.

K-Factor

The calibration constant for a pulse producing flowmeter expressed in pulses per unit volume

Linear

A flow measurement device where the output signal is proportional to flow.

Linear 16 Pt.

A mathematical approximation to a nonlinear device where by a correction factor or K-Factor table as a function of input signal is utilized to eliminate flowmeter nonlinearity.

Low Flow Cutoff

The value of input signal below which flow rate may be assumed to be 0 and at which totalization will cease.

Low Scale

The value of the process variable at the zero input signal.

Manual

An entry value to be used as a fixed condition in a equation

Meter Exp. Coef.

A coefficient in an equation which may be used to correct for changes in flowmeter housing dimensioned changes with temperature.

Mole %

The % composition of an individual gas in a gas mixture.

NX-19

A series of equations used to compute the compressibility of natural gas as a function of specific gravity, temperature, pressure and gas composition.

Protocol

An agreed upon method of information exchange.

Print Initiate

A user specified condition which must be satisfied for a transaction document to be printed.

Pulse Type

A menu selectable equivalent pulse output stage.

Pulse Value

An output scaling factor defining the equivalent amount of flow total represented by 1 output pulse.

Ref. Z-Factor

The Z-Factor for a gas at reference conditions of temperature and pressure.

Ref. Density

The density of a fluid at reference conditions of temperature and pressure.

Relay Function

The assigned usage for a relay output.

Relay Mode

The user's desired operating mode for the relay. Examples: follow, latch, timed pulse, above setpoint, below setpoint

Safe State

The state of an instrument's outputs which will occur during a power down state. The state the instrument assumes when the computations are paused.

10. Glossary of Terms (Continued)

Scroll List

The user's desired display list which can be presented on the two list display on Line 1 and/or L2 when the SCROLL key is depressed.

Self Check

A diagnostic sequence of steps a unit performs to verify it's operational readiness to perform it's intended function.

Service Test

A diagnostic sequence requiring specialized test apparatus to function to verify system readiness.

Setpoint

An alarm trip point.

Simulation

A special operating mode for an output feature which enables a service personnel to manually exercise the output during installation or trouble shooting operations.

Square Law Flowmeters

Types of measurement devices which measure differential pressure across a known geometry to make a flow measurement.

SQR LAW (Square Law w/o SQRT)

A square law flow measurement device equipped with a pressure transmitter with out a integral square root extractor.

SQR LAW-LIN (Square Law w/ SQRT)

A square law flow measurement device equipped with a pressure transmitter with integral square root extraction.

SQR Law 16PT (Square Law 16pt)

A mathematical approximation to a square law device where the discharge coefficient is represented as a table of DP Factor vs Reynold's Number.

Steam Delta Heat

A computation of the net heat of saturated steam equal to the total heat of steam minus the heat of water at the measured actual temperature.

Steam Heat

A computation of the total heat of steam.

Steam Net Heat

A computation of the net heat of steam equal to the total heat of steam minus the heat of water at the same saturated temperature.

STP Reference

The user's desired pressure and/or temperature to be considered as the reference condition in the computation of fluid properties or corrected volume conditions.

TAG

An alphanumeric designation for a particular instrument.

Time Constant

An averaging filter constant used to reduce bounce on the analog output. The high the number the slower the response, the greater filtering.

UVC

Universal Viscosity Curve is a representation of the calibration factor for a turbine flowmeter. It is expressed as a table of K-Factor as a function of Hz/CSTKS.

Viscosity Coef

A parameter in an equation which is used to estimate the viscosity as a function of temperature.

11. Diagnosis and Troubleshooting

11.1 Response of EA403 on Error or Alarm:

Error indications which occur during operation are indicated alternately with the measured values. The EA403 Flow Computer has four types of error:

TYPE OF ERROR	DESCRIPTION
System Alarms	Errors detected due to system failure
Sensor/Process Alarms	Errors detected due to sensor failure or process alarm conditions
Service Test Errors	Errors detected due to problems found during service test. (Service test can only be performed by qualified Factory service technicians because service code and special equipment are needed)
Self Test Errors	Errors detected during self test. (Each time the unit is powered, it runs a self test)

11.2 Diagnosis Flow Chart and Troubleshooting

All instruments undergo various stages of quality control during production. The last of these stages is a complete calibration carried out on state-of-the-art calibration rigs. A summary of possible causes is given below to help you identify faults.

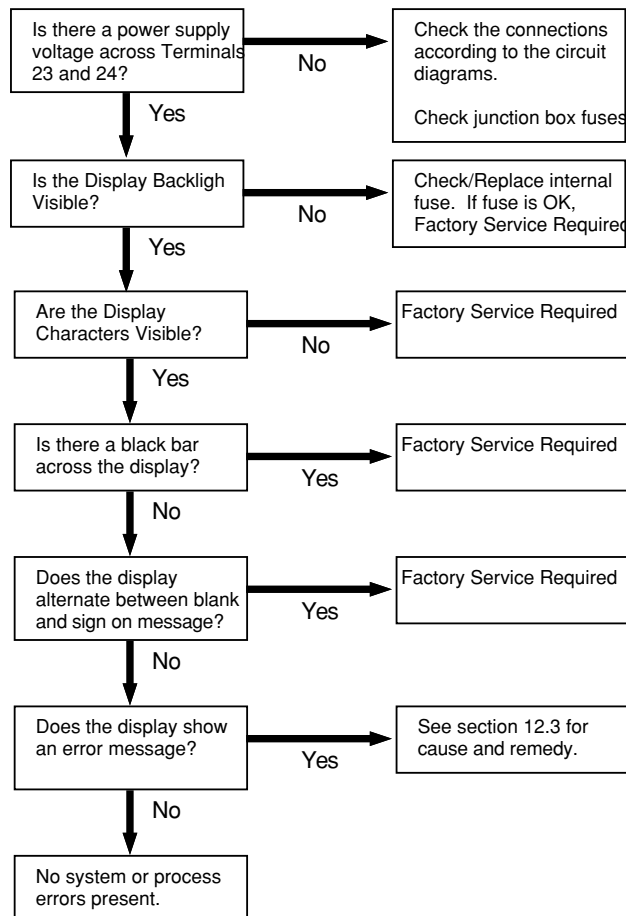

11.3 Error Messages:

NOTE: The 24 VDC output has a self resetting fuse.

Error Message	Cause	Remedy
POWER FAILURE	Power has been interrupted	Acknowledge Error Remedy not required
WATCHDOG TIMEOUT	Possible transient	Acknowledge Error Remedy not required
COMMUNICATION ERROR	Possible Improper wiring or usage Message Transmission failure.	Check wiring and communication settings / protocol
CALIBRATION ERROR	Operator Error	Repeat Calibration
PRINT BUFFER FULL	Print buffer full, Data may be lost	Check paper and printer connections
WET STEAM ALARM	Temperature or pressure input has gone below the saturated steam range of the internal steam tables	Check application, Insure that all sensors are working properly
OFF FLUID TABLE	Temperature or pressure input has gone below or exceeded the range of the internal steam tables	Check application, Insure that all sensors are working properly
FLOW IN OVERRANGE	Flow input has exceeded input range (if stacked, may be lo or hi transmitter)	Check sensor calibration
INPUT 1 OVERRANGE	Input 1 signal from sensor has exceeded input range	Check sensor calibration
INPUT 2 OVERRANGE	Input 2 signal from sensor has exceeded input range	Check sensor calibration
INPUT 3 OVERRANGE	Input 3 signal from sensor has exceeded input range	Check sensor calibration
FLOW LOOP BROKEN	Open circuit detected on flow input (if stacked, may be lo or hi transmitter)	Check wiring and sensor
LOOP 1 BROKEN	Open circuit detected on input 1	Check wiring and sensor
LOOP 2 BROKEN	Open circuit detected on input 2	Check wiring and sensor
LOOP 3 BROKEN	Open circuit detected on input 3	Check wiring and sensor
RTD 1 OPEN	Open circuit detected on RTD 1 input	Check wiring and RTD
RTD 1 SHORT	Short circuit detected on RTD 1 input	Check wiring and RTD

11.3 Error Messages: (Continued)

Error Message	Cause	Remedy
RTD 2 OPEN	Open circuit detected on RTD 2 input	Check wiring and RTD
RTD 2 SHORT	Short circuit detected on RTD 2 input	Check wiring and RTD
PULSE OUT OVERRUN	Pulse output has exceeded the internal buffer	Adjust pulse value or pulse width
Iout 1 OUT OF RANGE	Current output 1 is below or above specified range	Adjust the "0"/ "Full Scale" values or increase/ lower flowrate
Iout 2 OUT OF RANGE	Current output 1 is below or above specified range	Adjust the "0"/ "Full Scale" values or increase/ lower flowrate
TOTALIZER ERROR		
RELAY 1 HI ALARM	Relay 1 is active due to high alarm condition	Not required
RELAY 1 LO ALARM	Relay 1 is active due to low alarm condition	Not required
RELAY 2 HI ALARM	Relay 2 is active due to high alarm condition	Not required
RELAY 2 LO ALARM	Relay 2 is active due to low alarm condition	Not required
RELAY 3 HI ALARM	Relay 3 is active due to high alarm condition	Not required
RELAY 3 LO ALARM	Relay 3 is active due to low alarm condition	Not required
24VDC OUT ERROR	24V output error detected during service test run	By Factory Service
PULSE IN ERROR	Pulse input error detected during service test run	By Factory Service
INPUT 1 Vin ERROR	Error detected on input 1 voltage input during service test run	By Factory Service
INPUT 1 Iin ERROR	Error detected on input 1 current input during service test run	By Factory Service
INPUT 2 Iin/RTD ERROR	Error detected on input 2 during service test run	By Factory Service
INPUT 3 Iin/RTD ERROR	Error detected on input 3 during service test run	By Factory Service

11.3 Error Messages: (Continued)

Error Message	Cause	Remedy
PULSE OUT ERROR	Pulse output error detected during service test run	By Factory Service
Iout 1 ERROR	Current output 1 error detected during service test run	By Factory Service
Iout 2 ERROR	Current output 2 error detected during service test run	By Factory Service
RELAY 1 ERROR	Relay 1 error detected during service test run	By Factory Service
RELAY 2 ERROR	Relay 2 error detected during service test run	By Factory Service
RS-232 ERROR	RS-232 error detected during service test run	By Factory Service
A/D MALFUNCTION	Error detected in A/D converter during self test	By Factory Service
PROGRAM ERROR	Error on access to the program memory	By Factory Service
SETUP DATA LOST	All or part of the EEPROM data for setup is damaged or has been overwritten	Re-Enter setup data, If problem persists, Factory service required
TIME CLOCK LOST	The real time clock data was lost during extended power outage	Re-Enter time and date
DISPLAY MALFUNCTION	A display malfunction has been detected.	By Factory Service
RAM MALFUNCTION	Part or all of the internal RAM is damaged	By Factory Service
TRAP ERROR	Steam trap malfunction	Service steam trap
TRAP BLOWING	Steam trap malfunction	Change error delay
DATALOG LOST	Contents of datalog were corrupt and lost	Clear datalog, Clear errors

Appendix A - Fluid Properties Table
Fluid Properties Table
LIQUID

FLUID	REF. DENSITY (lb./ft ³)	REF. TEMP. (°F)	COEFF. OF EXPANSION	COMBUSTION HEAT (Btu/lb) LIQUID H ₂ O and CO ₂	SPECIFIC HEAT (Btu/lb °F)	LIQ.VISC. ANDREDE'S EQUATION COEFF. "A"	VISCOSITY BY ANDREDE'S EQUATION COEFF. "B"
AIR	54.56	-317.8	0.0016262	0	0.45	0.172	0
AMMONIA	42.63	-28.2	0.0005704	0	1.05	0.00157	2228.25
ARGON	86.89	-302.6	0.0014861	0	0.45	0.011291	511.34
CO2	65.333	-10.0	0.0012609	0	0.45	0.000001	5305.44
METHANE	26.48	-258.7	0.0010523	23920	0.80	0.006819	526.08
NATURAL GAS	26.48	-258.7	0.0010523	23920	0.80	0.006819	526.08
NITROGEN	50.44	-320.4	0.0014917	0	0.55	0.006524	434.94
OXYGEN	71.21	-297.4	0.0013458	0	0.41	0.019773	340.29
PROPANE	31.671	60	0.0007178	21690	0.6	0.009969	1267.35
Nx-19	26.48	-258.7	0.0010523	23920	0.80	0.006819	526.08
GASOLINE	46.8	60	0.0003703	20400	0.5	0.045617	1432.26
KEROSENE	51.79	60	0.0002681	18400	0.45	0.004378	3245.78
No. 2 FUEL	58.97	60	0.0000885	17970	0.42	0.000453	4946.15
WATER	62.37	60	0.0001015	0	1	0.001969	3315.61
HYDROGEN							
ETHANE							
HELIUM							

GAS

FLUID	REF. DENSITY (lb./ft ³)	REF. TEMP. (°F)	REF. Z FACTOR (14.696 PSIA)	Z FACTOR AT 100 PSIA and 60°F	SPECIFIC HEAT (Btu/lb °F)	COMBUSTION HEAT (Btu/lb) LIQUID H ₂ O and CO ₂	ISENTROPIC EXPONENT	VISCOSITY BY ANDREDE'S EQUATION COEFF. "A"	VISCOSITY BY ANDREDE'S EQUATION COEFF. "B"
AIR	0.076	60	1	0.997	0.24	0	1.4	0.000138	0.775522
AMMONIA	0.045	60	1	0.955	0.52	0	1.31	0.000013	1.05951
ARGON	0.105	60	1	0.995	0.125	0	1.67	0.00021	0.750757
CO2	0.116	60	1	0.954	0.21	0	1.32	0.000049	0.91136
METHANE	0.042	60	1	0.970	0.55	23920	1.31	0.000018	1.015892
NAT. GAS	0.0456	60	1	0.970	0.55	23920	1.31	0.000018	1.015892
NITROGEN	0.074	60	1	0.998	0.25	0	1.41	0.000202	0.7128734
OXYGEN	0.084	60	1	0.995	0.22	0	1.41	0.000169	0.761811
PROPANE	0.116	60	1	0.870	0.4	21690	1.14	0.00002	0.952092
Nx-19	0.0456	60	1	0.97	0.55	23920	1.31	0.000018	1.015892
HYDROGEN									
ETHANE									
HELIUM									

Appendix B - Setup Menus

SETUP MENUS
Operator Code Access

START HERE

SYSTEM PARAMETER

EZ SETUP	ACCESS CODE	FLOW EQUATION	ENTER DATE	ENTER TIME	DAYLIGHT SAVINGS	OPERATOR CODE	TAG #	ORDER CODE	SERIAL #	SENSOR SERIAL#
----------	-------------	---------------	------------	------------	------------------	---------------	-------	------------	----------	----------------

DISPLAY

SCROLL LIST	DISPLAY DAMPING	MAX. DEC. POINT	LANGUAGE
-------------	-----------------	-----------------	----------

SYSTEM UNITS

TIME BASE	HEAT FLOW UNIT	HEAT TOTAL UNIT	MASS FLOW UNIT	MASS TOTAL UNIT	COR. VOL. FLOW UNIT	COR. VOL. TOTAL UNIT	VOLUME FLOW UNIT	VOLUME TO TAL UNIT	DEFINITION DBI	TEMPERATURE UNIT	PRESSURE UNIT	DENSITY UNIT	SPEC. ENTPY UNIT	LENGTH UNIT
-----------	----------------	-----------------	----------------	-----------------	---------------------	----------------------	------------------	--------------------	----------------	------------------	---------------	--------------	------------------	-------------

FLUID DATA

FLUID TYPE	REF. DENSITY	THERM. EXP. COEF.	COMBUSTION HEAT	SPECIFIC HEAT	FLOW Z. FACTOR	REF. Z. FACTOR	ISENTROPIC EXP.	MOLE % NITROGEN	MOLE % CO2	VISCOSITY COEF. A	VISCOSITY COEF. B
------------	--------------	-------------------	-----------------	---------------	----------------	----------------	-----------------	-----------------	------------	-------------------	-------------------

FLOW INPUT

FLOWMETER TYPE	SQUARE LAW FLOWMETER	INPUT SIGNAL	LOW SCALE	FULL SCALE	LOW SCALE HIGH RANGE	FULL SCALE HIGH RANGE	SWITCH UP	SWITCH DOWN	LOW FLOW CUTOFF	CALIBRATION DENSITY	K-FACTOR	PIPE INNER DIAMETER	ENTER BETA	METER EXP. COEF
----------------	----------------------	--------------	-----------	------------	----------------------	-----------------------	-----------	-------------	-----------------	---------------------	----------	---------------------	------------	-----------------

COMPENSATION INPUT

1	INPUT SIGNAL	LOW SCALE VALUE	FULL SCALE VALUE	DEFAULT VALUE	STP REFERENCE	CALIBRATION TEMP	LOW DELTA T CUTOFF	VIEW INPUT SIGNAL	TRAP ERROR DELAY	TRAP BLOWING DELAY
2	INPUT SIGNAL	LOW SCALE VALUE	FULL SCALE VALUE	DEFAULT VALUE	STP REFERENCE	BAROMETRIC PRESS	VIEW INPUT SIGNAL			

PULSE OUTPUT

ASSIGN PULSE OUTPUT	PULSE TYPE	PULSE VALUE	PULSE WIDTH	SIMULATION FREQ.
---------------------	------------	-------------	-------------	------------------

CURRENT OUTPUT

1	ASSIGN CURRENT OUT	CURRENT RANGE	LOW SCALE VALUE	FULL SCALE VALUE	TIME CONSTANT	CURRENT OUT VALUE (DISPLAY)	SIMULATION CURRENT
2	ASSIGN CURRENT OUT	CURRENT RANGE	LOW SCALE VALUE	FULL SCALE VALUE	TIME CONSTANT	CURRENT OUT VALUE (DISPLAY)	SIMULATION CURRENT

RELAYS

SELECT RELAY FUNCTION 1, 2, 3	RELAY MODE	LIMIT SETPOINT	PULSE VALUE	HYSTERESIS	RELAY SIMULATION	RESET ALARM
-------------------------------	------------	----------------	-------------	------------	------------------	-------------

COMMUNICATION

RS232 USAGE	DEVICE ID	BAUD RATE	PARITY	HANDSHAKE	PRINT LIST	PRINT INITIATE	DATALOG ONLY	PRINT INTERVAL	PRINT TIME	DATALOG FORMAT	MODEM CONTROL	DEVICE MASTER	SEND INC TOT ONLY	INC ONLY SCALER	CLEAR DATALOG
-------------	-----------	-----------	--------	-----------	------------	----------------	--------------	----------------	------------	----------------	---------------	---------------	-------------------	-----------------	---------------

NETWORK CARD

PROTOCOL	DEVICE ID	BAUD RATE	PARITY
----------	-----------	-----------	--------

SERVICE & ANALYSIS

EXAMINE AUDIT TRAIL	ERROR LOG	SOFTWARE VERSION (DISPLAY)	HARDWARE VERSION (DISPLAY)	PRINT SYSTEM SETUP	SELF CHECK
---------------------	-----------	----------------------------	----------------------------	--------------------	------------

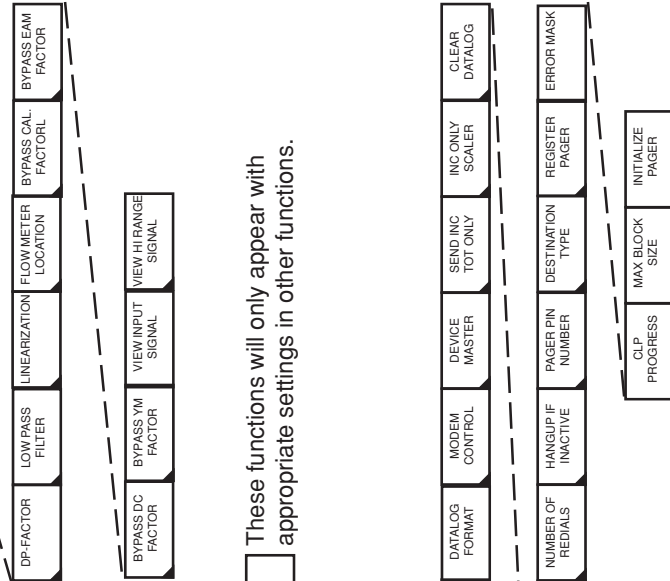

These functions will only appear with appropriate settings in other functions.

Appendix B- Setup Menus (continued)

SETUP MENUS Service Code Access

START HERE

SYSTEM PARAMETER	EZ SETUP	ACCESS CODE	FLOW EQUATION	ENTER DATE	ENTER TIME	DAYLIGHT SAVINGS	OPERATOR CODE	SUPERVISOR CODE	ENGINEERING CODE	TAG #	ORDER CODE	SERIAL #	SENSOR SERIAL#			
DISPLAY	SCROLL LIST	DISPLAY DAMPING	MAX. DEC. POINT	LANGUAGE												
SYSTEM UNITS	TIME BASE	HEAT FLOW UNIT	HEAT TOTAL UNIT	MASS FLOW UNIT	MASS TOTAL UNIT	COR. VOL. FLOW UNIT	COR. VOL. TOTAL UNIT	VOLUME FLOW UNIT	VOLUME TOTAL UNIT	DEFINITION	TEMPERATURE UNIT	PRESSURE UNIT	DENSITY UNIT	SPEC. ENTHALPY UNIT	LENGTH UNIT	
FLUID DATA	FLUID TYPE	REF. DENSITY	THERM. EXP. COEF.	COMBUSTION HEAT	SPECIFIC HEAT	FLOW Z. FACTOR	REF. Z. FACTOR	ISENTROPIC EXP.	MOLE % NITROGEN	MOLE % CO2	VISCOSITY COEF. A	VISCOSITY COEF. B				
FLOW INPUT	FLOWMETER TYPE	SQUARE LAW FLOWMETER	INPUT SIGNAL	LOW SCALE	FULL SCALE	LOW SCALE HIGH RANGE	FULL SCALE HIGH RANGE	SWITCH UP	SWITCH DOWN	LOW FLOW CUTOFF	CALIBRATION DENSITY	K-FACTOR	PIPE INNER DIAMETER	ENTER BETA	MIETER EXP. COEF.	
COMPENSATION INPUT	1 SELECT INPUT	INPUT SIGNAL	LOW SCALE VALUE	FULL SCALE VALUE	DEFAULT VALUE	STP REFERENCE	CALIBRATION TEMP	LOW DELTA T CUTOFF	VIEW INPUT SIGNAL	TRAP ERROR DELAY	TRAP BLOWING DELAY					
	2	INPUT SIGNAL	LOW SCALE VALUE	FULL SCALE VALUE	DEFAULT VALUE	STP REFERENCE	BAROMETRIC PRESS	VIEW INPUT SIGNAL								
PULSE OUTPUT	ASSIGN PULSE OUTPUT	PULSE TYPE	PULSE VALUE	PULSE WIDTH	SIMULATION FREQ.											
CURRENT OUTPUT	1 SELECT OUTPUT	ASSIGN CURRENT OUT	CURRENT RANGE	LOW SCALE VALUE	FULL SCALE VALUE	TIME CONSTANT	CURRENT OUT VALUE (DISPLAY)	SIMULATION CURRENT								
	2	ASSIGN CURRENT OUT	CURRENT RANGE	LOW SCALE VALUE	FULL SCALE VALUE	TIME CONSTANT	CURRENT OUT VALUE (DISPLAY)	SIMULATION CURRENT								
RELAYS	SELECT RELAY 1, 2, 3	RELAY FUNCTION	RELAY MODE	LIMIT SETPOINT	PULSE WIDTH	HYSTERESIS	RELAY SIMULATION	RESET ALARM								
COMMUNICATION	RS232 USAGE	DEVICE ID	BAUD RATE	PARITY	HANDSHAKE	PRINT LIST	PRINT INITIATE	DATALOG ONLY	PRINT INTERVAL	PRINT TIME	DATALOG FORMAT	MODEM CONTROL	DEVICE MASTER	SEND INC TOT ONLY	INC ONLY SCALER	CLEAR DIALOG
NETWORK CARD	PROTOCOL	DEVICE ID	BAUD RATE	PARITY												
SERVICE & ANALYSIS	EXAMINE AUDIT TRAIL	ERROR LOG	SOFTWARE VERSION (DISPLAY)	HARDWARE VERSION (DISPLAY)	CALIBRATION (DISPLAY)	RESTORE FACTORY CALIBRATION	NEXT CALIBRATION	PRINT MAINT. REPORT	PRINT SYSTEM SETUP	SELF-CHECK	SERVICE TEST					

These functions will only appear with appropriate settings in other functions.



WARRANTY

This product is warranted against defects in materials and workmanship for a period of one (1) year from the date of shipment to Buyer.

The Warranty is limited to repair or replacement of the defective unit at the option of the manufacturer. This warranty is void if the product has been altered, misused, dismantled, or otherwise abused.

ALL OTHER WARRANTIES, EXPRESSED OR IMPLIED, ARE EXCLUDED, INCLUDING BUT NOT LIMITED TO THE IMPLIED WARRANTIES OF MERCHANTABILITY AND FITNESS FOR A PARTICULAR PURPOSE.

Ordering Information

SERIES:

EA403 Flow Computer

Display Type :

Backlit LCD

Power Input :

85 to 276 VAC

Mounting Style:

Panel Mount

Flow Input:

Pulse

4-20 mA (Linear)

4-20 mA (Square Root)

Stacked DP Transmitter

Other:

AGA NX-19 Calculation for Natural Gas